

Temperature Controller
NFY Series
Ver 1.0

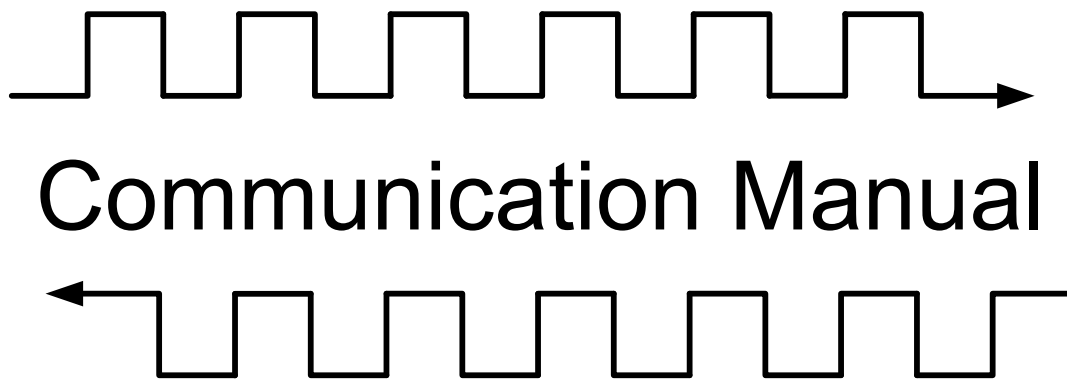

台灣儀控股份有限公司
TAIWAN INSTRUMENT & CONTROL CO., LTD

Contents

1. Communication Specifications	1
2. System Configuration.....	2
2.1 RS-485 Configuration.....	2
3. Wiring	3
3.1 RS-485 Wiring	3
4. Communication Parameter Setting	4
4.1 Setting Communication Parameter	4
4.2 Communication Parameter Functionality Outline.....	5
4.3 Procedure for Communication Parameter Setting	6
5. TAIE Protocol	9
5.1 Function Code	9
5.2 Checksum	9
5.3 Read A Register Format.....	10
5.4 Write A Register Format	10
5.5 Modify A Register Format.....	10
5.6 More Examples of Read/Write/Modify Example.....	11
5.6.1 Read a register	11
5.6.2 Write a register	11
5.6.3 Modify a register	12
6. Modbus RTU Protocol.....	13
6.1 Message Structure	13
6.2 Read Register Format	14
6.2.1 Read a register format.....	14
6.2.2 Read multi register format	15
6.3 Write Register Format	15
6.3.1 Write a register format	15
6.3.2 Write multi register format.....	15
6.4 More Examples of Read/Write	16
6.4.1 Read a register	16
6.4.2 Read multi register	16
6.4.3 Write a register	17
6.4.4 Write multi register.....	17
6.5 Error Code.....	18
6.5.1 Read Errors	18
6.5.2 Write Errors.....	18
6.5.3 Error command	19
6.6 EEPROM Protection Function.....	20
7. Communication Parameter address	21
7.1 General Parameters Address	21
7.2 Program Parameters Address	33

1. Communication Specifications

TAIE Protocol

Interface	RS-485
Baud rate	2400 bps \ 4800 bps \ 9600 bps \ 19200 bps \ 38400 bps \ 57600 bps \ 115200 bps
Data format	Parity bit: None \ Odd \ Even Data bit: 8 Stop bit: 1 or 2
Interval time	0~250ms
Function code	52H : Read 4DH : Modify 57H : Write
Error check	Sum of communication data, with Low Byte as error check.
Protocol	TAIE
MAX Number connections	Up to 31 units

MODBUS RTU Protocol

Interface	RS-485
Baud rate	2400 bps \ 4800 bps \ 9600 bps \ 19200 bps \ 38400 bps \ 57600 bps \ 115200 bps
Data format	Parity bit: None \ Odd \ Even Data bit: 8 Stop bit: 1 or 2
Interval time	0~250ms
Function code	03H : Read 06H : Write 10H : Multiple write
Error check	CRC-16
Error code	01H : Function code error 02H : Register address error 03H : Data count error
Protocol	Modbus RTU
MAX Number connections	Up to 31 units

2. System Configuration

2.1 RS-485 Configuration

MAX number of connection unit for RS-485 communication interface is 31.

The spanning distance for controller connection PC Cable should not be more than 1200 meters.

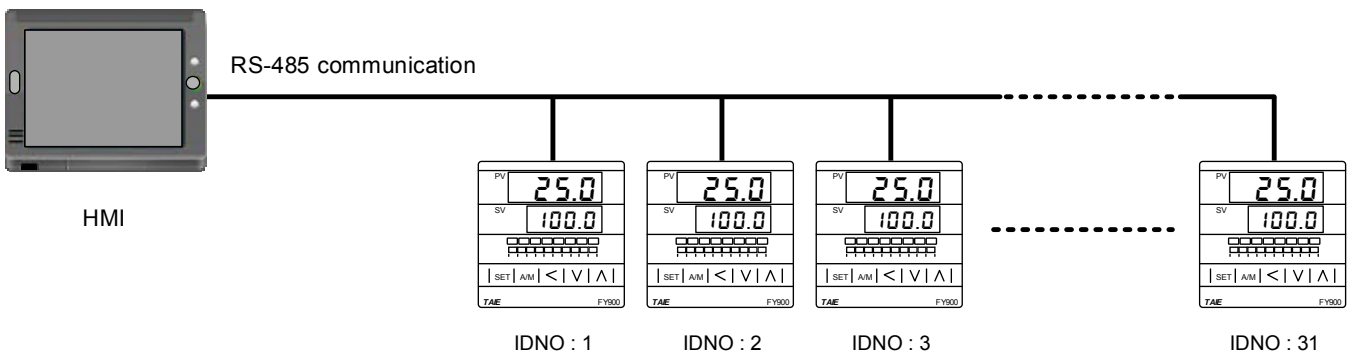
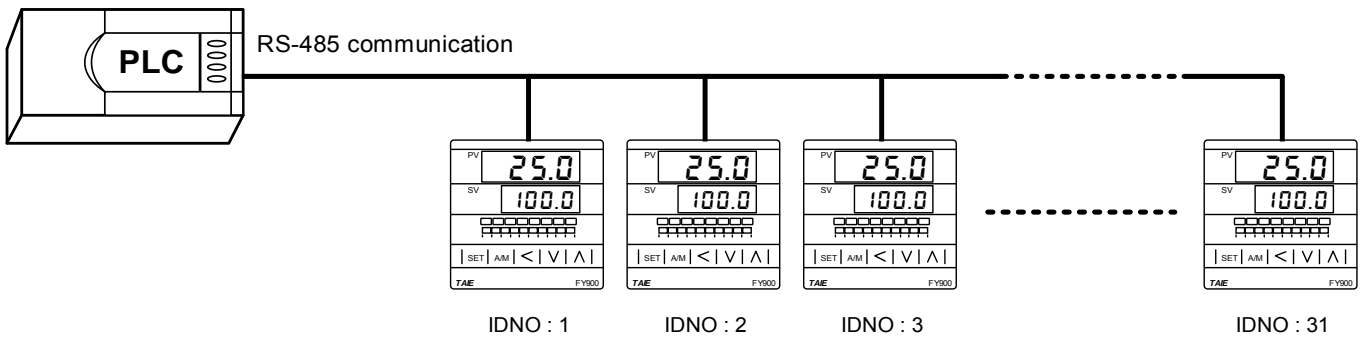
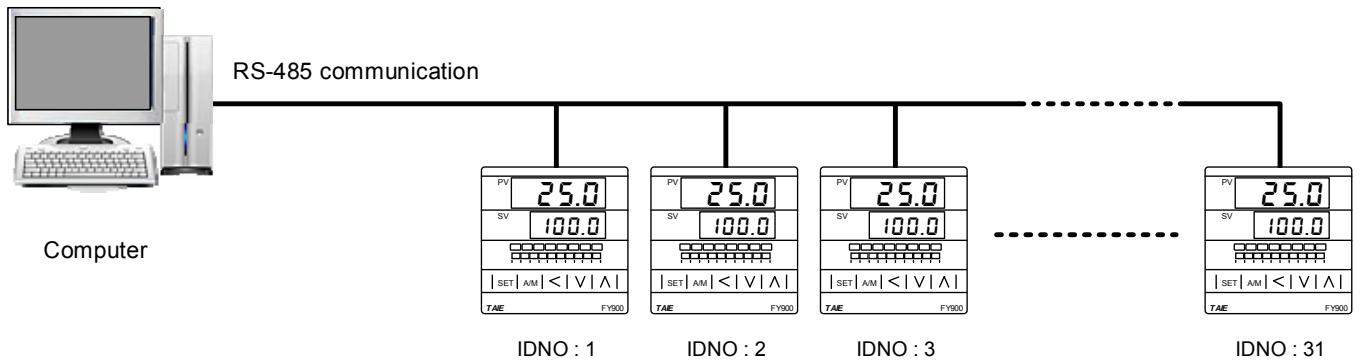

3. Wiring

3.1 RS-485 Wiring

Use KA301 Converter to connect with controller

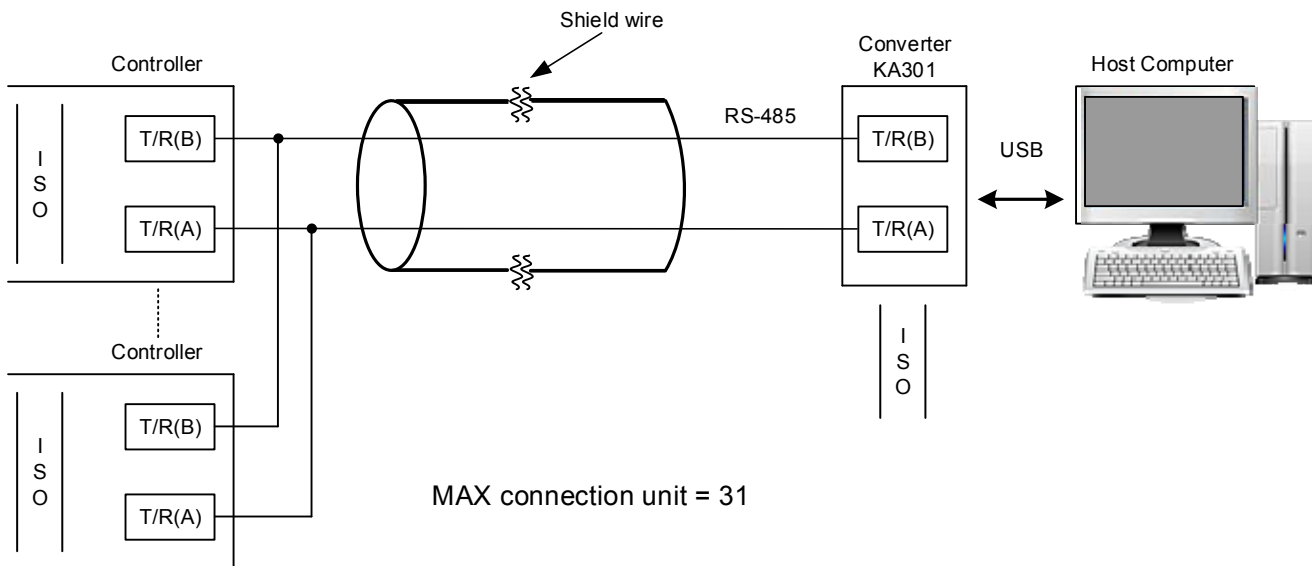

※ The spanning distance for controller connection PC Cable should not be more than 1200 meters.

Use IC485SN Converter connected to controller

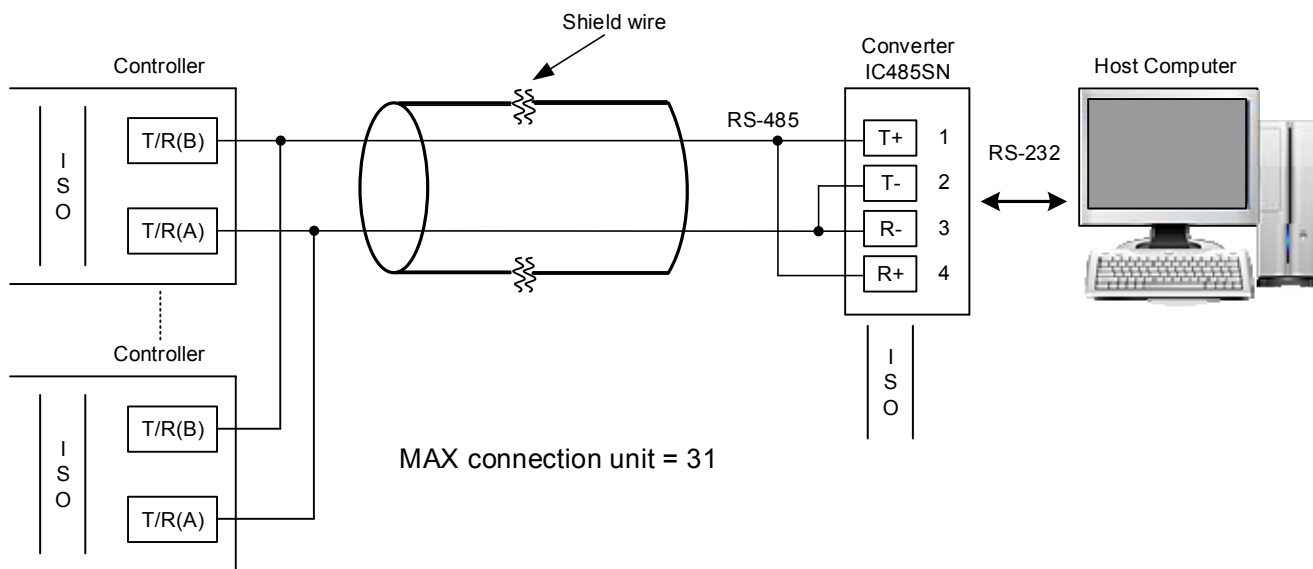

※ The spanning distance for controller connection PC Cable should not be more than 1200 meters.

4. Communication Parameter Setting

4.1 Setting Communication Parameter

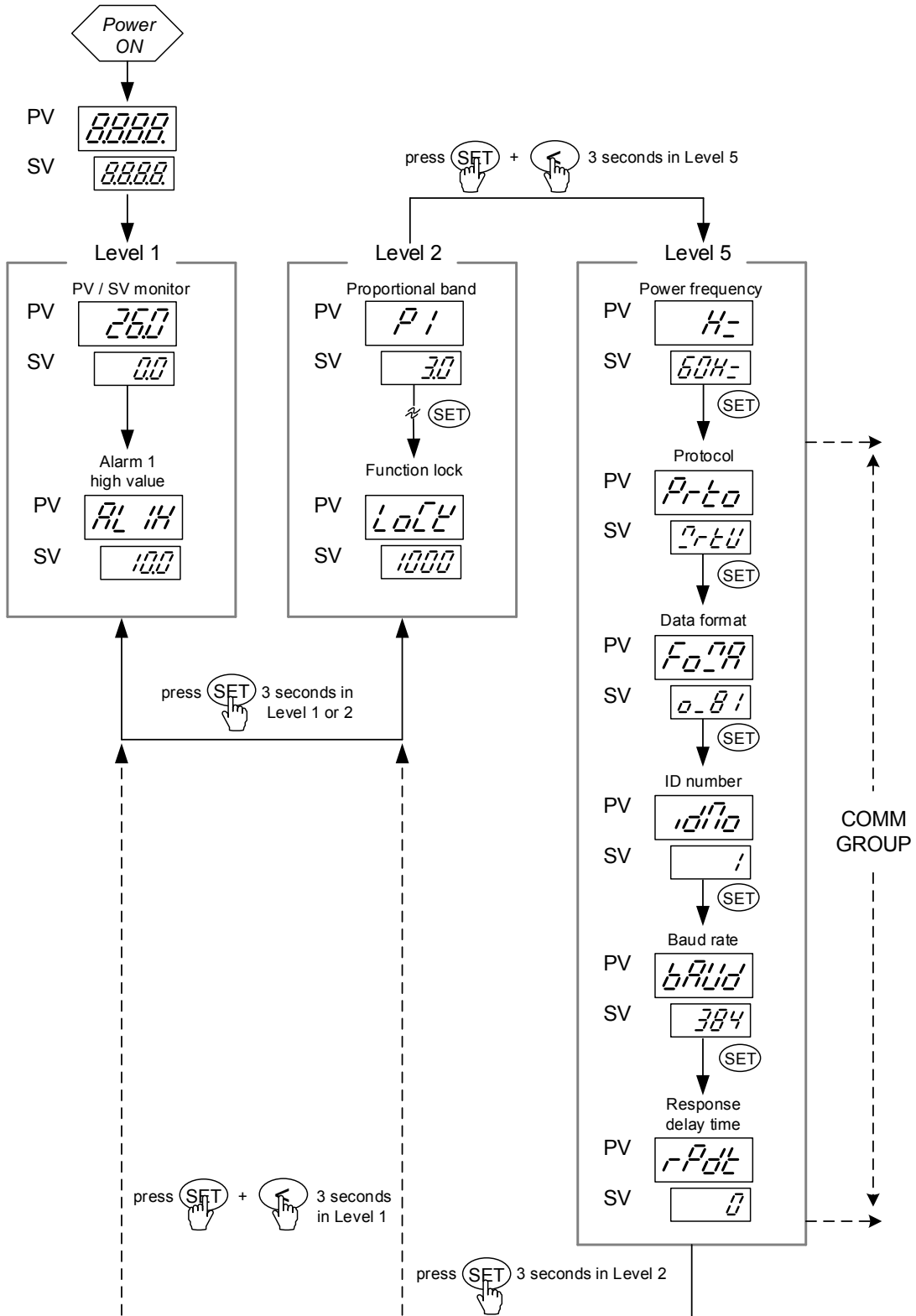

4.2 Communication Parameter Functionality Outline

Symbol	Content	Data Range	Initial
<i>0200</i>	Communication Protocol	<i>0200</i> : Modbus RTU	<i>0200</i>
		<i>0201</i> : TAIE	
<i>0202</i>	Data format	<i>0202</i> : None parity data bits =8 stop bit =1	<i>0202</i>
		<i>0203</i> : None parity data bits =8 stop bit =2	
		<i>0204</i> : Odd parity data bits =8 stop bit =1	
		<i>0205</i> : Odd parity data bits =8 stop bit =2	
		<i>0206</i> : Even parity data bits =8 stop bit =1	
		<i>0207</i> : Even parity data bits =8 stop bit =2	
<i>0208</i>	Controller address	<i>0208</i> : 0~255	<i>0208</i>
<i>0209</i>	Baud rate	<i>0209</i> : 2400 bps	<i>0209</i>
		<i>0210</i> : 4800 bps	
		<i>0211</i> : 9600 bps	
		<i>0212</i> : 19200 bps	
		<i>0213</i> : 38400 bps	
		<i>0214</i> : 57600 bps	
		<i>0215</i> : 115200 bps	
<i>0216</i>	Response delay time	Response delay time(ms) When the controller receives command from master server, it will relay data back to master server in a delay of the set time value here.	<i>0216</i>
<i>0217</i>	Write mode	OFF : As controller receives write-register command, it would only write to CPU RAM, not into EEPROM.	<i>0217</i>
		ON : As controller receives write-register command, it would write to both CPU RAM and EEPROM , at the same time.	

4.3 Procedure for Communication Parameter Setting

1. Power ON & Initialization completed

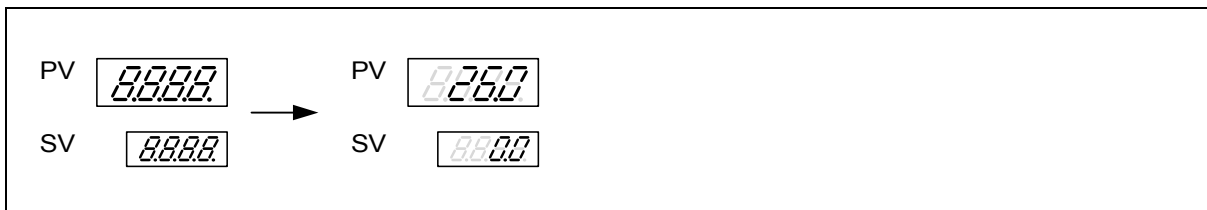

2. Press SET key 3 seconds, will enter Level2.

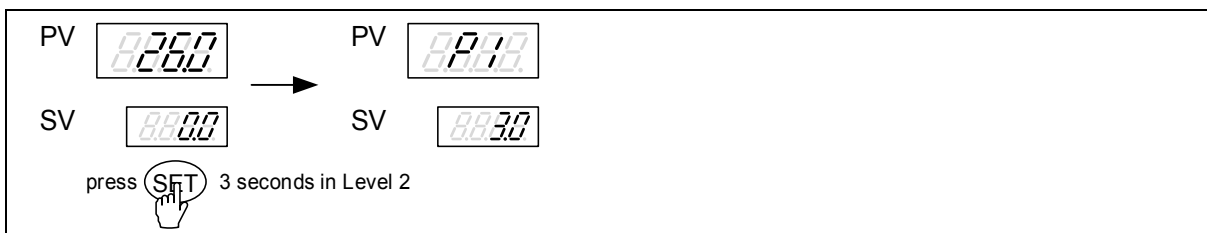

3. Press SET key to search upper display showing the value indicated here. *0668*

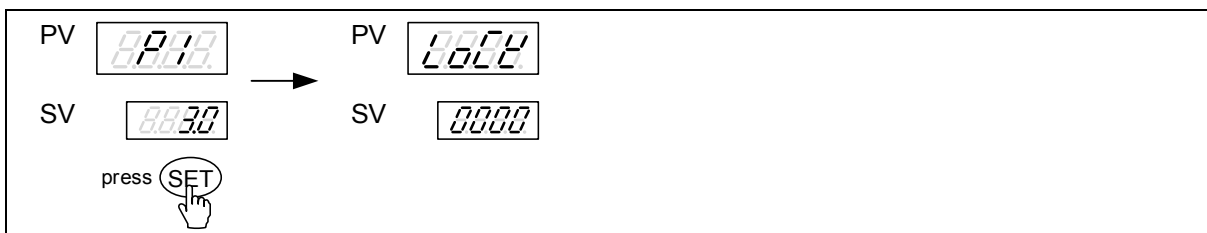

4. Set LOCK to 1000 , press SET key + SHIFT key for 3 seconds to enter Level 5

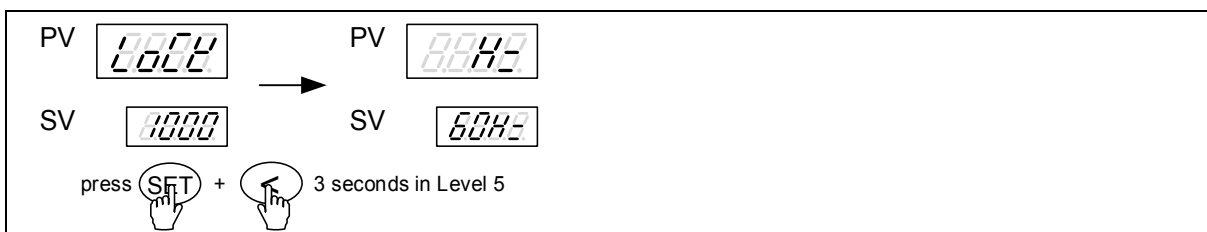

5. Press SET key to search upper display showing the value indicated here. *8888*

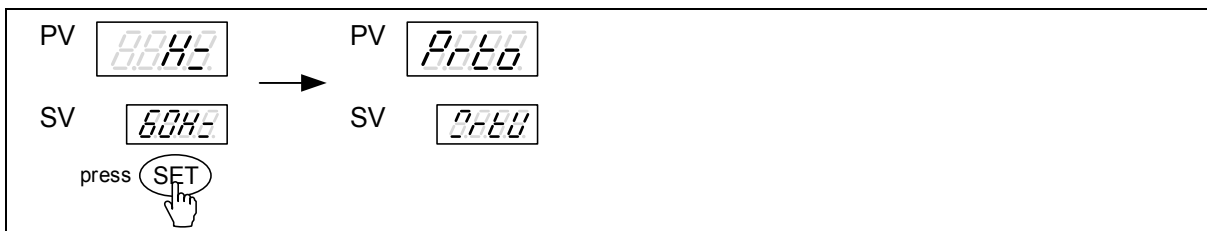

6. Press SHIFT key then lower display will start flash , press UP key or DOWN key to select communication protocol then pressing SET key to save the current setting .

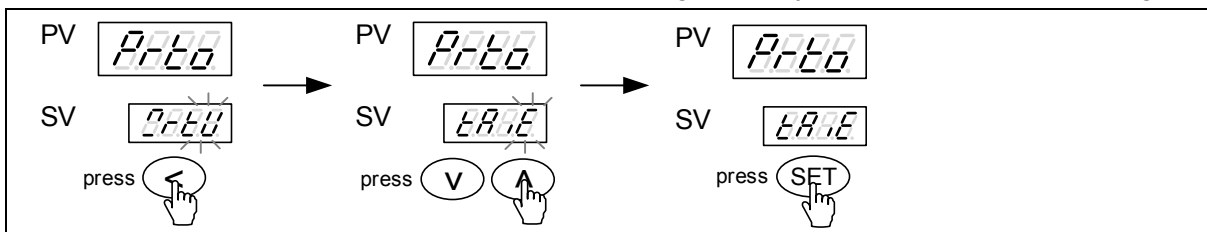

7. Press SET key to search upper display showing the value indicated here. *F000*

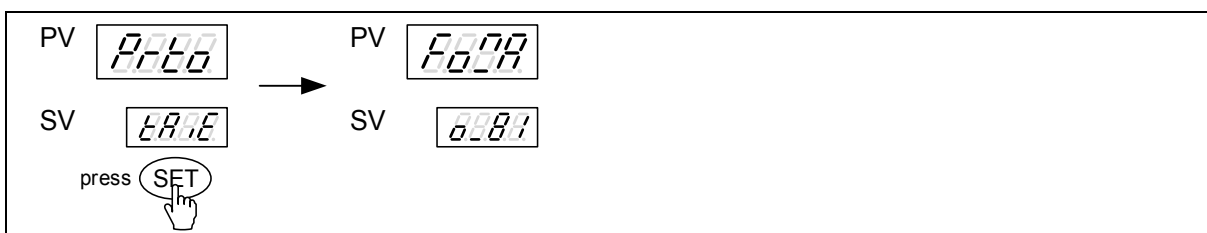

8. Press SHIFT key then lower display will start flash , press UP key or DOWN key to select DATA format then pressing SET key to save the current setting.

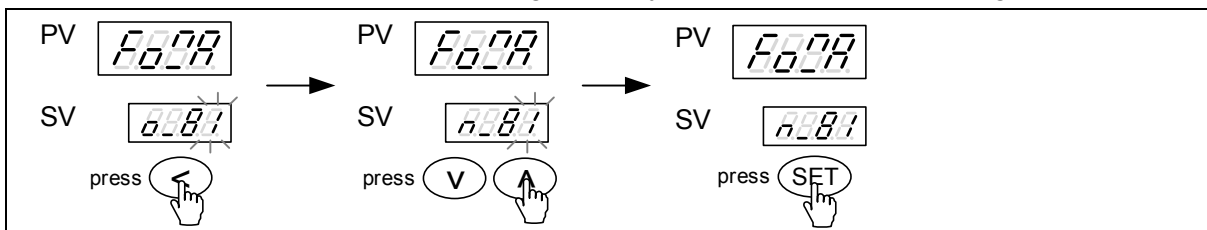

9. Press SET key to search upper display showing the value indicated here. *0000*

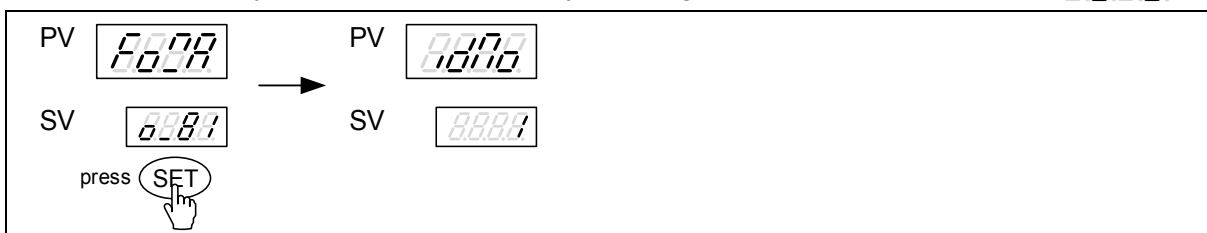

10. Press SHIFT key then lower display will start flash , press UP key or DOWN key to select slave address then pressing SET key to save the current setting.

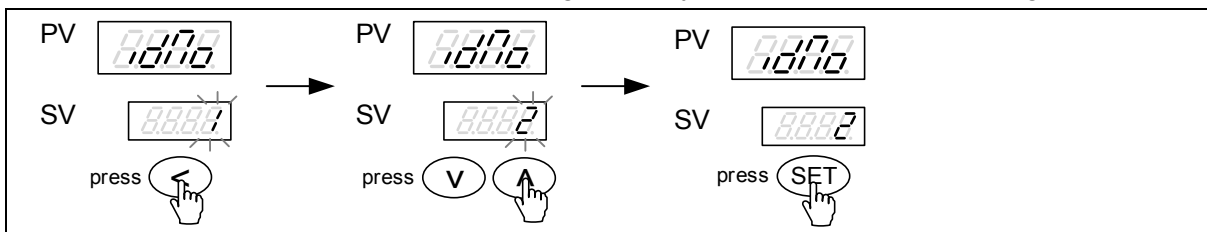

11. Press SET key to search upper display showing the value indicated here. *6900*

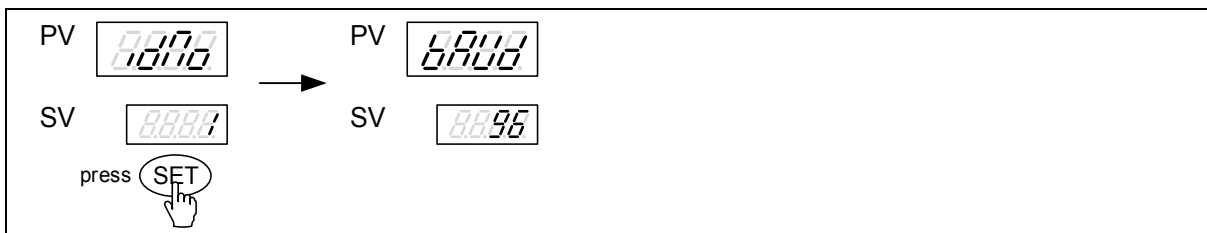

12. Press SHIFT key then lower display will start flash , press UP key or DOWN key to select baud rate then pressing SET key to save the current setting.

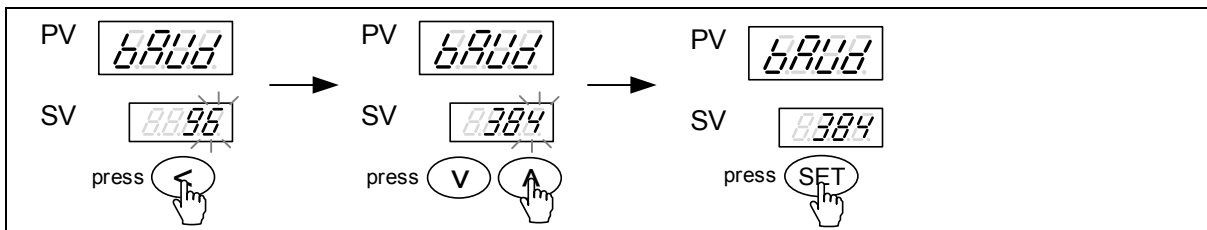

13. Press SET key to search upper display showing value indicated here. *7200*

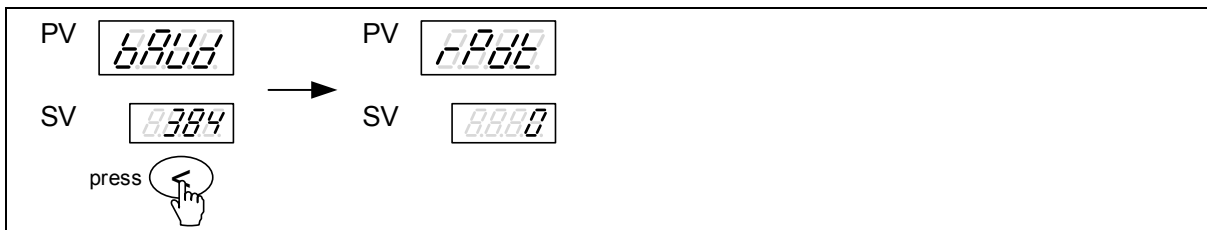

14. Press SHIFT key then lower display will start flash , press UP key or DOWN key to select communication response delay time(ms) then pressing SET key to save the current setting .

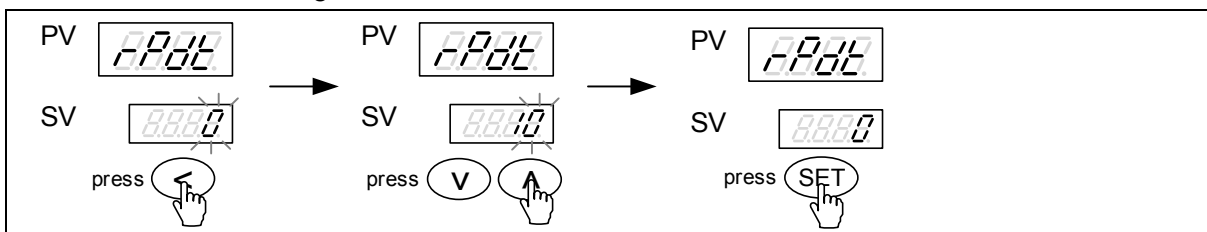

5. TAIE Protocol

5.1 Function Code

Function Code	Command	Content
'R' (52H)	Read	Reading 1 registered value from slave controller
'M' (4DH)	Modify	Temporarily write 1 registered value to controller's RAM. (Default value will be restored when controller is powered off)
'W' (57H)	Write	Write 1 registered value to controller's RAM and EEPROM. (Data are maintained after power off)

5.2 Checksum

Add all the values from "Command" to the end of "Data". The result is Checksum (1 byte).

$$\boxed{\text{Command}} + \boxed{\text{ID}} + \boxed{\text{data address}} + \boxed{\text{data}} = \boxed{\text{checksum}} \rightarrow \boxed{\text{low byte}}$$

※ The Data response not include (Header)07H

EX (1) : Read the SV value of controller.

command	+	station	+	register address	+	data	=	Add all	→	checksum (get low byte)
('R') 52 H		01 H		0001H		03E8 H		013F H		3F H

EX (2) : Temporary write to SV value of controller.

command	+	station	+	register address	+	data	=	Add all	→	checksum (get low byte)
('M') 4D H		01 H		0001 H		03E8 H		013A H		3A H

EX (3) : Write to SV value of controller.

command	+	station	+	register address	+	data	=	Add all	→	checksum (get low byte)
('W') 57 H		01 H		0001 H		03E8 H		0144 H		44 H

5.3 Read A Register Format

Master send:

Master Send	No. of Byte	1	2	3	4	5	6	7
	Command	52H('R')	01H	00H	00H	00H	00H	53H
	Comment	Read	ID Number	Register Address		Data		Checksum

Controller response:

Controller response	No. of Byte	0	1	2	3	4	5	6	7
	Command	07H	4DH('M')	01H	00H	00H	03H	E8H	39H
	Comment	Header	Read	ID Number	Register Address		Data		Checksum

5.4 Write A Register Format

Master send:

Master Send	No. of Byte	1	2	3	4	5	6	7
	Command	57H('W')	01H	00H	01H	03H	E8H	44H
	Comment	Write	ID Number	Register Address		Data		Checksum

Controller response:

Controller response	No. of Byte	1	2
	Command	4FH('O')	4BH('K')
	Comment	Message	

5.5 Modify A Register Format

Master send:

Master Send	No. of Byte	1	2	3	4	5	6	7
	Command	4DH('M')	01H	00H	01H	00H	64H	B3H
	Comment	Modify	ID Number	Register Address		Data		Checksum

Controller response:

Controller response	No. of Byte	1	2
	Command	4FH('O')	4BH('K')
	Comment	Message	

5.6 More Examples of Read/Write/Modify Example

5.6.1 Read a register

(1) Read P1, if P1=10.0

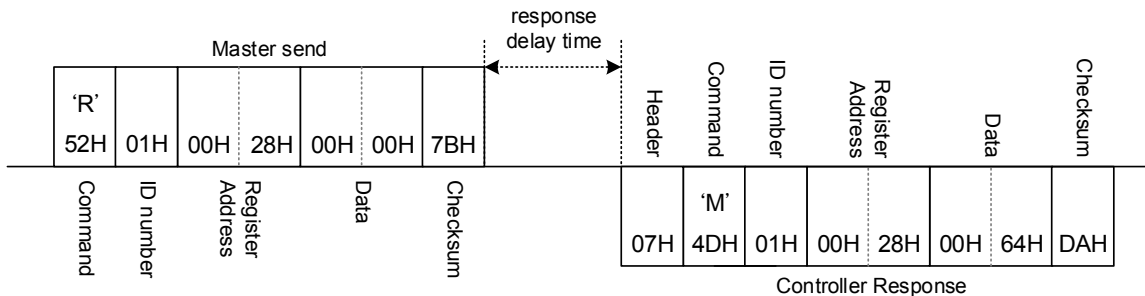

(2) Read AL1H, if AL1H =1234

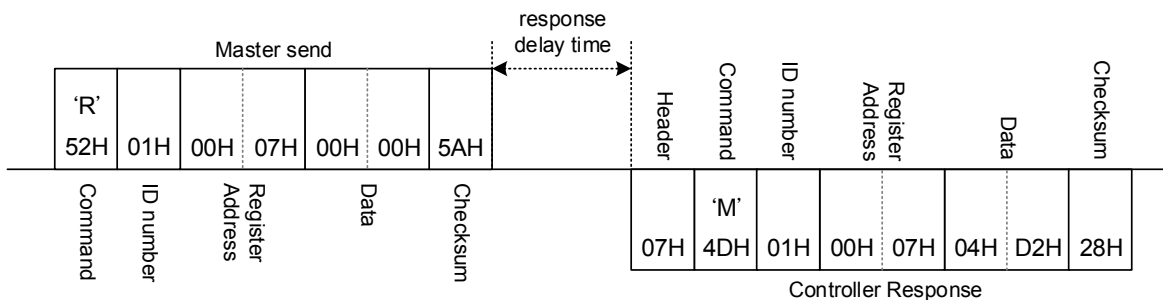

5.6.2 Write a register

(1) Write AT =ON

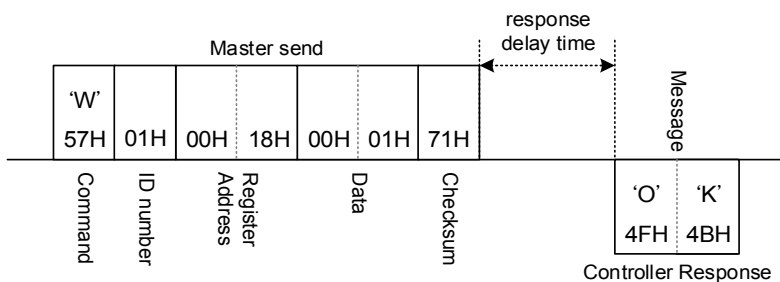

(2) Write CYT1 =10

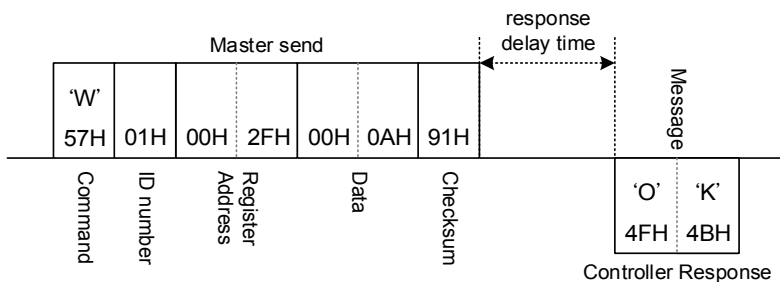

5.6.3 Modify a register

(1) Write SV =500

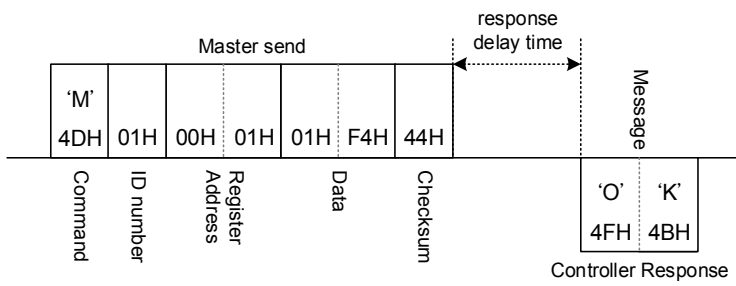

(2) Write R_S =RUN

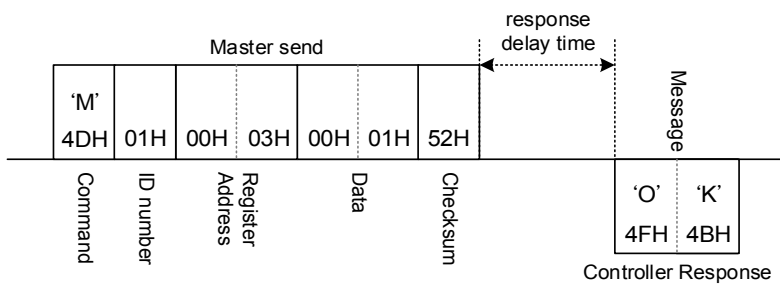

6. Modbus RTU Protocol

6.1 Message Structure

ID number
Function Code
Data
CRC-16 Modbus

ID number :
ID number range is 01H to FFH (1 to 255).

Function Code:

command	content
03 H (Multi-Read)	Reading multiple registers value from slave controller (Max register count : 25)
06 H (Single-Write)	Write 1 register value to controller's RAM and EEPROM.
10 H (Multi-Write)	Write Multi-register value to controller's RAM and EEPROM. (Max register count : 8)

CRC-16 Modbus:

CRC-16 Modbus generation step are as below:

step 1 : CRC = FFFF(Hex) 2 Byte

step 2 : Calculate XOR with 1st data (start with n=1) and the low byte of CRC.

step 3 : If CRC data byte is 1

→ CRC = CRC >> 1;

CRC^ = 0XA001;

or

→ CRC = CRC >> 1;

step 4 : Repeat step 3, do 8 times.

step 5 : Repeat step 2~4 finished the end of one.

step 6 : Reverse CRC's L/H(Byte), get CRD.

EX(1) Read to SV:

No. of Byte	1	2	3	4	5	6	7	8
Command	01 H	03 H	00 H	01 H	00 H	01 H	D5H	CA H
Comment	Station	Function Code	Register Address		Data Count		CRC-16 Modbus	

EX(2) Write to SV =1000:

No. of Byte	1	2	3	4	5	6	7	8
Command	01 H	06H	00 H	01 H	03 H	E8 H	D8 H	B4 H
Comment	Station	Function Code	Register Address		Data Count		CRC-16 Modbus	

EX(3) Write to AL1H =10, AL1L =5:

No. of Byte	1	2	3	4	5	6	7	8	9	10	11	12	13
Command	01 H	10 H	00 H	07H	00 H	02 H	04 H	00 H	0A H	00 H	05 H	52 H	48 H
Comment	Station	Function Code	Register Address		Data Count	Data Byte		Data 1		Data 2		CRC-16 Modbus	

CRC-16 refer to: <http://www.lammertbies.nl/comm/info/crc-calculation.html>

On-line CRC calculation and free library

- [Introduction on CRC calculations](#)
- [Free CRC calculation routines for download](#)
- [CRC calculation support forum](#) **New**

"010300000001" (hex)

1 byte checksum	5
CRC-16	0x1184
CRC-16 (Modbus)	0x0A84
CRC-16 (Sick)	0x1108
CRC-CCITT (XModem)	0xBB53
CRC-CCITT (0xFFFF)	0xB543
CRC-CCITT (0x1D0F)	0x8A6D
CRC-CCITT (Kermit)	0x6E08
CRC-DNP	0x4C19
CRC-32	0x4A393840

010300000001

Input type: ASCII Hex

6.2 Read Register Format

6.2.1 Read a register format

Master send (Read SV):

Master Send	No. of Byte	1	2	3	4	5	6	7	8
	Command	01H	03H	00H	01H	00H	01H	D5H	CAH
	Comment	ID Number	Command	Register Address		Data Count		CRC-16 Modbus	

Controller response (If SV = 100.0):

Controller response	No. of Byte	1	2	3	4	5	6	7
	Command	01H	03H	02H	03H	E8H	B8H	FAH
	Comment	ID Number	Command	Data Byte Count	Data		CRC-16 Modbus	

6.2.2 Read multi register format

NFY controller can read up to 25 parameter information at a time, as user can choose the number of 1~25 for the number of data can be read at a time.

Master send (Read AL1H, AL1L):

Master Send	No. of Byte	1	2	3	4	5	6	7	8
	Command	01H	03H	00H	07H	00H	02H	75H	CAH
	Comment	ID Number	Command	Register Address		Data Count		CRC-16 Modbus	

Controller response:

Controller response	No. of Byte	1	2	3	4	5	6	7	8	9
	Command	01H	03H	04H	00H	0AH	00H	05H	1AH	32H
	Comment	ID Number	Command	Data Byte Count	Data 1		Data 2		CRC-16 Modbus	

6.3 Write Register Format

6.3.1 Write a register format

Master send (Write SV =100):

Master Send	No. of Byte	1	2	3	4	5	6	7	8
	Command	01H	06H	00H	01H	00H	64H	D9H	E1H
	Comment	ID Number	Command	Register Address		Data Count		CRC-16 Modbus	

Controller response:

Controller response	No. of Byte	1	2	3	4	5	6	7	8
	Command	01H	06H	00H	01H	00H	64H	D9H	E1H
	Comment	ID Number	Command	Register Address		Data Count		CRC-16 Modbus	

6.3.2 Write multi register format

NFY controller can read up to 8 parameter information at a time, as users can choose the number of 1~8 for the number of data can be read at a time. in multi write mode approve master device write 8 registers once, user can setting 1~8 number in Data Count field.

Master send (Write AL1H =10, AL1L =5):

Master Send	No. of Byte	1	2	3	4	5	6	7	8	9	10	11	12	13
	Command	01H	10H	00H	07H	00H	02H	04H	00H	0AH	00H	05H	52H	48H
	Comment	ID Number	Command	Register Address		Data Count		Data Byte Count	Data 1		Data 2		CRC-16 Modbus	

Controller response:

Controller response	No. of Byte	1	2	3	4	5	6	7	8
	Command	01H	10H	00H	07H	00H	02H	F0H	09H
	Comment	ID Number	Command	Register Address		Data Count		CRC-16 Modbus	

6.4 More Examples of Read/Write

6.4.1 Read a register

(1) Read P1 , If P1 =10.0

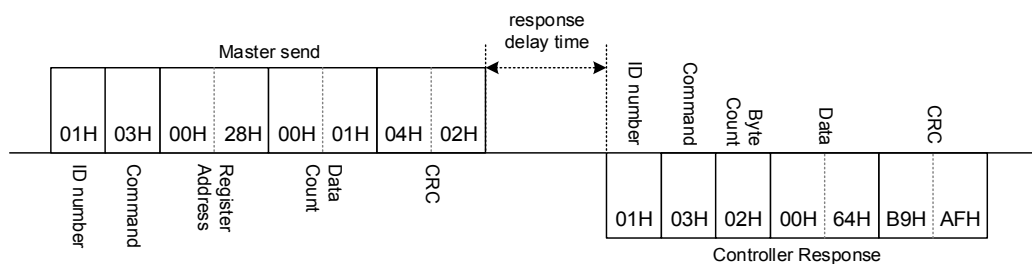

(2) Read AT , If AT =OFF

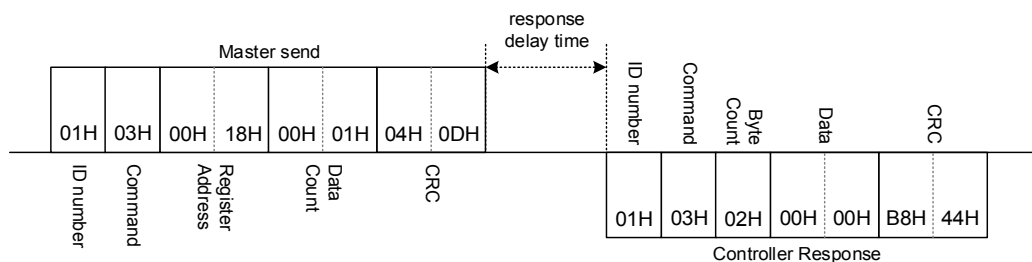

6.4.2 Read multi register

(1) Read AL1H, AL1L, AL2H,AL2L , If AL1H=10.0, AL1L=10.0, AL2H=5.0, AL2L=5.0

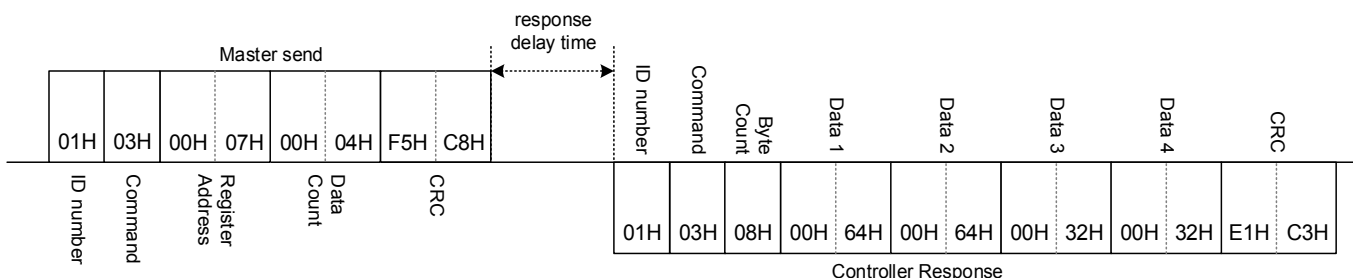

6.4.3 Write a register

(1) Write AT =ON

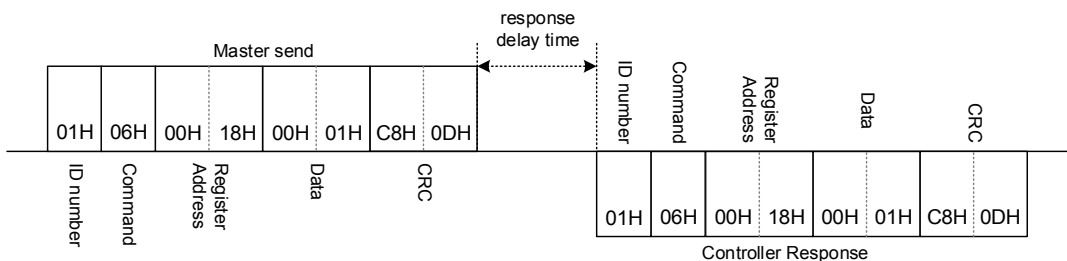

(2) Write CYT1 =10

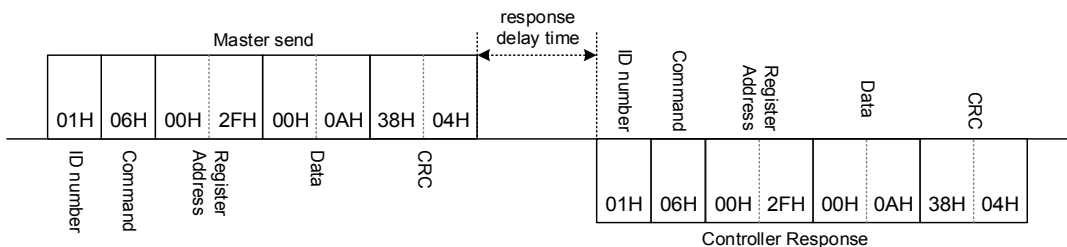

6.4.4 Write multi register

(1) Continuous write AL1H, AL1L, AL2H,AL2L , If AL1H=10.0, AL1L=10.0, AL2H=5.0, AL2L=5.0

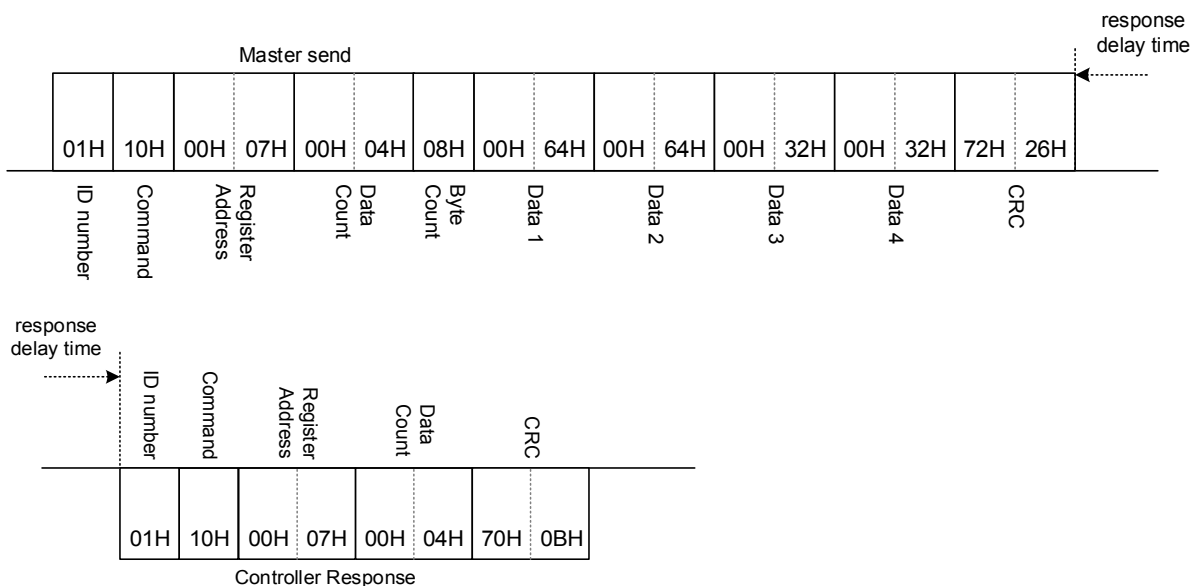

6.5 Error Code

Code	Content
(01H)	Illegal function code (Non-existent function code)
(02H)	Illegal register address (Register address is out of range)
(03H)	Illegal data count (Data count is out of setting range)

※ 1 is set to the MSB of function code in abnormal status.

6.5.1 Read Errors

(1) Register address is out of range

Master send:

Master Send	No. of Byte	1	2	3	4	5	6	7	8
	Command	01H	03H	FFH	FFH	00H	01H	84H	2EH
	Comment	ID Number	Command	Register Address(error)		Data Count		CRC-16 Modbus	

Controller response:

Controller response	No. of Byte	1	2	3	6	7
	Command	01H	83H	02H	C0H	F1H
	Comment	ID Number	Command (MSB=1)	Error Code	CRC-16 Modbus	

(2) Data count is out of setting range

Master send:

Master Send	No. of Byte	1	2	3	4	5	6	7	8
	Command	01H	03H	00H	00H	00H	1EH	C5H	C2H
	Comment	ID Number	Command	Register Address		Data Count (over range)		CRC-16 Modbus	

Controller response:

Controller response	No. of Byte	1	2	3	6	7
	Command	01H	83H	03H	01H	31H
	Comment	ID Number	Command (MSB=1)	Error Code	CRC-16 Modbus	

6.5.2 Write Errors

(1) Register address is out of range

Master send:

Master Send	No. of Byte	1	2	3	4	5	6	7	8
	Command	01H	06H	FFH	FFH	00H	00H	89H	EEH
	Comment	ID Number	Command	Register Address(error)		Data		CRC-16 Modbus	

Controller response:

Controller response	No. of Byte	1	2	3	6	7
	Command	01H	86H	02H	C3H	A1H
	Comment	ID Number	Command (MSB=1)	Error Code	CRC-16 Modbus	

(2) Data count is out of setting range

Master send:

Master Send	No. of Byte	1	2	3	4	5	6	7	8	9		
	Command	01H	10H	00H	02H	00	1A	12	00	64		
	Comment	ID Number	Command	Register Address	Data Count (over range)	Data Byte	Data 1				

Master Send	No. of Byte			24	25	26	27
	Command			00	64	C9	AC
	Comment	...	Data 9	CRC-16 Modbus			

Controller response:

Controller response	No. of Byte	1	2	3	6	7
	Command	01H	90H	03H	0CH	01H
	Comment	ID Number	Command (MSB=1)	Error Code	CRC-16 Modbus	

6.5.3 Error command

(1) Non-existent function code

Master send

Master Send	No. of Byte	1	2	3	4	5	6	7	8
	Command	01H	00H	00H	00H	00H	01H	C0H	0AH
	Comment	ID Number	Command (error)	Register Address	Data Count	CRC-16 Modbus			

Controller response:

Controller response	No. of Byte	1	2	3	6	7
	Command	01H	80H	01H	80H	00H
	Comment	ID Number	Command (MSB=1)	Error Code	CRC-16 Modbus	

6.6 EEPROM Protection Function

NFY memory system consists of EEPROM, each EEPROM memory has its physical limit, in terms of its memory count and memory duration span, therefore, a 24C16 EEPROM is capable of having a write-in count of one million times, and having its data to be kept for up to 10 years, so in the case of high-speed communication, if the master end only sends a write-in command, then it is highly possible that there would be over-cycle in a short period of time, i.e. the physical characteristics of this particular memory unit would have been destroyed and incapacitated, so in order to prevent this kind of functional defect, NFY controllers offer two types of protection modes, which are active protection and passive protection respectively, and for detailed information, please see the following outline.

(1) Active Protection

The controller will automatically compare write-in data, whether it be Modbus RTU or TAIE communication protocol. When any received data is the same as previously received data, the controller will not initiate write-in to EEPROM, and therefore, only different data shall be written in by the controller to EEPROM.

EX: SV initial value = 0, Master continues to write to controller's SV

1. Master send SV = 1000
NFY EEPROM : will write to 1000
2. Master send SV = 1000
NFY EEPROM : No action
3. Master send SV = 1000
NFY EEPROM : No action
4. Master send SV = 500
NFY EEPROM : will write to 500
5. Master send SV = 500
NFY EEPROM : No action
6. Master send SV = 500
NFY EEPROM : No action

(2) Passive Protection

Set W_MD into OFF, when the controller received communication write-in command, it would only write in CPU RAM, not EEPROM, which brings relief to the potential over-cycle problem, however, its shortcoming is that, any data written in prior to system re-boot will not be kept.

EX1 : Set W_MD into OFF, SV initial = 0, Master send SV = 1000

Master send : 01H 06H 00H 01H 03H E8H D8H B4H
NFY RAM (SV) = 1000
NFY EEPROM : No action

EX2 : Set W_MD into OFF, SV initial = 0, Master send SV = 1000

Master send : 01H 06H 00H 01H 03H E8H D8H B4H
NFY RAM (SV) = 1000
NFY EEPROM : write to 1000

※ This parameter (W_MD) cannot be written in via communication command, as it can only be set in the controller setting, as ON or OFF.

7. Communication Parameter address

7.1 General Parameters Address







Parameter	Display	Level	Description	Range		Address				R/W	Initial
				Max	Min	LOOP1		LOOP2			
						Hex	Dec	Hex	Dec		
PV	0000	Level 1	Process value	USPL	LSPL	0x00	0	0x83	131	R	---
SV	0000	Level 1	Set value	USPL	LSPL	0x01	1	0x84	132	R/W	0
LOOP	0000	Level 1	Loop selection 0 : LOP1 (loop1) 1 : LOP2 (loop2)	1	0	0x02	2	0x85	133	R/W	0
R_S	0000	Level 1	RUN/STOP mode selection 0 : STOP (output & alarm disable) 1 : RUN (output & alarm enable)	1	0	0x03	3	0x86	134	R/W	0
HBCU	00.00	Level 1	HBA current display unit : ampere(A)	100.0	0.0	0x04	4	0x87	135	R	0
HBSV	00.00	Level 1	HBA current setting unit : ampere(A)	100.0	0.0	0x05	5	0x88	136	R/W	0
HBTM	0000	Level 1	HBA disconnection set time unit : second(S)	5999	0	0x06	6	0x89	137	R/W	10
AL1H	0000	Level 1	Alarm1 upper set value (ALD1 = DE.HI / DE.HL / BA.ND / PR.HI / DEHI / DEHL / BAND / PRHI appear)	9999	-1000	0x07	7	0x8A	138	R/W	10
AL1L	0000	Level 1	Alarm1 lower set value (ALD1 = DE.LO / DE.HL / BA.ND / PR.LO / DELO / DEHL / BAND / PRLO appear)	9999	-1000	0x08	8	0x8B	139	R/W	10
AL2H	0000	Level 1	Alarm2 upper set value (ALD2 = DE.HI / DE.HL / BA.ND / PR.HI / DEHI / DEHL / BAND / PRHI appear)	9999	-1000	0x09	9	0x8C	140	R/W	10
AL2L	0000	Level 1	Alarm2 lower set value (ALD2 = DE.LO / DE.HL / BA.ND / PR.LO / DELO / DEHL / BAND / PRLO appear)	9999	-1000	0x0A	10	0x8D	141	R/W	10
AL3H	0000	Level 1	Alarm3 upper set value (ALD3 = DE.HI / DE.HL / BA.ND / PR.HI / DEHI / DEHL / BAND / PRHI appear)	9999	-1000	0x0B	11	0x8E	142	R/W	10
AL3L	0000	Level 1	Alarm3 lower set value (ALD3 = DE.LO / DE.HL / BA.ND / PR.LO / DELO / DEHL / BAND / PRLO appear)	9999	-1000	0x0C	12	0x8F	143	R/W	10
SV1	0000	Level 1	First set value	USPL	LSPL	0x0D	13	0x90	144	R/W	0
SV2	0000	Level 1	Second set value	USPL	LSPL	0x0E	14	0x91	145	R/W	0
SV3	0000	Level 1	Third set value	USPL	LSPL	0x0F	15	0x92	146	R/W	0
SV4	0000	Level 1	Fourth set value	USPL	LSPL	0x10	16	0x93	147	R/W	0
TIM	0000	Level 1	Timer PV address use for current time SV address use for target time ※Need to use with DI function	5999	0	0x11	17	0x94	148	R/W	0
CNT	0000	Level 1	Counter PV address use for current count SV address use for target count ※Need to use with DI function	9999	0	0x12	18	0x95	149	R/W	0
CUTM	00.00	Level 1	24 hour timer Current setting time	23.59	00.00	0x13	19	0x96	150	R/W	0
ONTM	00.00	Level 1	24 hour timer , action ON time PV address use for display current time SV address use for setting action ON time	23.59	00.00	0x14	20	0x97	151	R/W	0
OFTM	00.00	Level 1	24 hour timer , action OFF time PV address use for display current time SV address use for setting action OFF time	23.59	00.00	0x15	21	0x98	152	R/W	0

7. Communication Data List

Parameter	Display	Level	Description	Range		Address				R/W	Initial
				Max	Min	LOOP1		LOOP2			
						Hex	Dec	Hex	Dec		
A_M		Level 1	Auto/Manual mode switch 0 : AUTO (auto mode) 1 : MMAN (main output manual mode) 2 : SMAN (sub output manual mode)	2	0	0x16	22	0x99	153	R/W	0
MOUT		Level 1	manual manipulated output setting value	100.0	0.0	0x17	23	0x9A	154	R/W	0
AT		Level 1	Auto-tuning execute selection 0 : OFF PID control 1 : ON execute auto tuning	1	0	0x18	24	0x9B	155	R/W	0
RATE		Level 1	Slave SV rate	9999	0	0x19	25	0x9C	156	R/W	9999
RAMP		Level 1	The rate of change during SV ramp operation format : °C / minute	99.99	-19.99	0x1A	26	0x9D	157	R/W	0
SOAK		Level 1	Soak time	5999	0	0x1B	27	0x9E	158	R/W	0
WAIT		Level 1	Program execution standby temperature 0 : when program execute do not wait for PV temperature Other values : when PV= (SV-WAIT) , program entering next segment	1000	0	0x1C	28	0x9F	159	R/W	0
DTM1		Level 1	DO1 Timer	5999	0	0x1D	29	0xA0	160	R/W	0
DTM2		Level 1	DO2 Timer	5999	0	0x1E	30	0xA1	161	R/W	0
DTM3		Level 1	DO3 Timer	5999	0	0x1F	31	0xA2	162	R/W	0
DTM4		Level 1	DO4 Timer	5999	0	0x20	32	0xA3	163	R/W	0
DT.ST		Level 1	Digit out timer set	5999	0	0x21	33	0xA4	164	R/W	0
PTN		Level 1	Program pattern selection	15	0	0x22	34	0xA5	165	R/W	0
SEG		Level 1	Program segment selection	10	1	0x23	35	0xA6	166	R/W	1
L1SV		Level 1	LOOP1 current segment temperature setting value	USPL	LSPL	0x24	36	0xA7	167	R/W	0
L2SV		Level 1	LOOP2 current segment temperature setting value	USPL	LSPL	0x25	37	0xA8	168	R/W	0
TIMR		Level 1	Current segment execute time setting END(-1) : program end in this segment 00.00 : program step in this segment 00.01~99.58 : program in this segment execute time COTI(99.59) : program continue execute this segment no end	5999	0	0x26	38	0xA9	169	R/W	0
DOUT		Level 1	DO1~DO4 ON/OFF setting 0000 = 0 0001 = 1 0010 = 16 0011 = 17 0100 = 256 0101 = 257 0110 = 272 0111 = 273 1000 = 4096 1001 = 4097 1010 = 4112 1011 = 4113 1100 = 4352 1101 = 4353 1110 = 4368 1111 = 4369	4369	0	0x27	39	0xAA	170	R/W	0

Parameter	Display	Level	Description	Range		Address				R/W	Initial
				Max	Min	LOOP1		LOOP2			
						Hex	Dec	Hex	Dec		
P1		Level 2	Main output proportional band 0 : ON/OFF control Other values : proportional band setting value	200.0	0.0	0x28	40	0xAB	171	R/W	3.0
I1		Level 2	Main output integral time 0 : disable integral function Other values : integral time setting value	3600	0	0x2A	42	0xAD	173	R/W	240
D1		Level 2	Main output derivative time 0 : disable derivative function Other values : derivative time setting value	900	0	0x2C	44	0xAF	175	R/W	60
HYS1		Level 2	Hysteresis for main output on/off control(when P1 = 0.0 appear)	1000	-1000	0x2E	46	0xB1	177	R/W	10
CYT1		Level 2	Main output control cycle 0 : Linear signal 1 : SSR drive 2~150 : Relay	150	0	0x2F	47	0xB2	178	R/W	10
MOLH		Level 2	High limit setting of manipulated value for main output	100.0	0.0	0x30	48	0xB3	179	R/W	100.0
MOLL		Level 2	low limit setting of manipulated value for main output	100.0	0.0	0x31	49	0xB4	180	R/W	0.0
P2		Level 2	sub output proportional band 0 : ON/OFF control Other values : proportional band setting value	200.0	0.0	0x32	50	0xB5	181	R/W	3.0
I2		Level 2	sub output integral time 0 : disable integral function Other values : integral time setting value	3600	0	0x34	52	0xB7	183	R/W	240
D2		Level 2	sub output derivative time 0 : disable derivative function Other values : derivative time setting value	900	0	0x36	54	0xB9	185	R/W	60
HYS2		Level 2	Hysteresis for sub output on/off control(when P2 = 0.0 appear)	1000	-1000	0x38	56	0xBB	187	R/W	10
CYT2		Level 2	sub output control cycle 0 : Linear signal 1 : SSR drive 2~150 : Relay	150	0	0x39	57	0xBC	188	R/W	10
SOLH		Level 2	High limit setting of manipulated value for sub output	100.0	0.0	0x3A	58	0xBD	189	R/W	100.0
SOLL		Level 2	low limit setting of manipulated value for sub output	100.0	0.0	0x3B	59	0xBE	190	R/W	0.0
MGAP		Level 2	Control gap (for main output)	1000	-1000	0x3C	60	0xBF	191	R/W	0
SGAP		Level 2	Control gap (for sub output)	1000	-1000	0x3D	61	0xC0	192	R/W	0
COUT		Level 2	Manipulated value for output	100.0	0.0	0x3E	62	0xC1	193	R	0.0
AT.VL		Level 2	Auto tuning offset value execute auto tuning in (SV-ATVL) point	1000	-1000	0x3F	63	0xC2	194	R/W	0
SS.PO		Level 2	In manual mode or error condition controller will load this setting value as manipulate value	100.0	0.0	0x40	64	0xC3	195	R/W	50.0

7. Communication Data List

Parameter	Display	Level	Description	Range		Address				R/W	Initial
				Max	Min	LOOP1		LOOP2			
						Hex	Dec	Hex	Dec		
OPSF		Level 2	Main output special function selection 0 : NONE (special function OFF) 1 : SQUA (manipulated output value square) 2 : ROOT (manipulated output value square root) 3 : REVE (manipulated output value reverse) 4 : SQ.RE (manipulated output value square reverse) 5 : RO.RE (manipulated output value square root reverse)	5	0	0x41	65	0xC4	196	R/W	0
RC.TO		Level 2	Output filter Unit : second	10.00	0.01	0x42	66	0xC5	197	R/W	0.20
LOCK		Level 2	Function/level lock 0000 = 0 0001 = 1 0010 = 16 0011 = 17 0100 = 256 0101 = 257 0110 = 272 0111 = 273 1000 = 4096 1001 = 4097 1010 = 4112 1011 = 4113 1100 = 4352 1101 = 4353 1110 = 4368 1111 = 4369	4369	0	0x43	67	0xC6	198	R/W	0
INPT		Level 3	Input type selection 0 : K1 (-50.0~600.0°C) 1 : K2 (-50~1200°C) 2 : J1 (-50.0~400.0°C) 3 : J2 (-50~400°C) 4 : R (-50~1760°C) 5 : S (-50~1760°C) 6 : B (-50~1820°C) 7 : E (-50~900°C) 8 : N (-50~1300°C) 9 : T1 (-199.9~400.0°C) 10 : T2 (-199~400°C) 11 : W (-50~2320°C) 12 : PL (-50~1200°C) 13 : L (-50~800°C) 14 : PT1 (-199.9~850.0°C) 15 : PT2 (-199~850°C) 16 : PT3 (0~850°C) 17 : AN1 18 : AN2 19 : AN3 20 : AN4	22	0	0x44	68	0xC7	199	R/W	17
AN.LO		Level 3	Analog input zero calibration	9999	-1999	0x45	69	0xC8	200	R/W	0
AN.HI		Level 3	Analog input span calibration(hex format)	0x7FFF	0	0x46	70	0xC9	201	R/W	0x5FFF
DP		Level 3	Decimal point position (only available in linear signal input) 0 : 0000 1 : 000.0 2 : 00.00 3 : 0.000	3	0	0x47	71	0xCA	202	R/W	0

Parameter	Display	Level	Description	Range		Address				R/W	Initial
				Max	Min	LOOP1		LOOP2			
						Hex	Dec	Hex	Dec		
HI.RA		Level 3	Input scale high(for analog input)	9999	-1999	0x48	72	0xCB	203	R/W	---
LO.RA		Level 3	Input scale low(for analog input)	9999	-1999	0x49	73	0xCC	204	R/W	---
USPL		Level 3	Input scale high(for Thermocouple or RTD)	9999	-1999	0x4A	74	0xCD	205	R/W	---
LSPL		Level 3	Input scale low(for Thermocouple or RTD)	9999	-1999	0x4B	75	0xCE	206	R/W	---
ALD1		Level 3	Alarm1 mode selection 0 : NONE 1 : DE.HI 2 : DE.LO 3 : DE.HL 4 : BA.ND 5 : PR.HI 6 : PR.LO 7 : PEND 8 : SYAB 9 : HBA 10 : MSOK 11 : DEHI 12 : DELO 13 : DEHL 14 : BAND 15 : PRHI 16 : PRLO 17 : PRUN 18 : SYNO 19 : SOAK 20 : TIM 21 : CNT 22 : CUTM	25	0	0x4C	76	0xCF	207	R/W	11
ALT1		Level 3	FLIK (00.00) : Flicker COTI (99.59) : Continued ON 00.01~99.58 : delay time	5999	0	0x4D	77	0xD0	208	R/W	5999
HYA1		Level 3	Hysteresis setting for alarm1	1000	0	0x4E	78	0xD1	209	R/W	0
SEA1		Level 3	Alarm1 special function setting 0000 = 0 0001 = 1 0010 = 16 0011 = 17 0100 = 256 0101 = 257 0110 = 272 0111 = 273 1000 = 4096 1001 = 4097 1010 = 4112 1011 = 4113 1100 = 4352 1101 = 4353 1110 = 4368 1111 = 4369	4369	0	0x4F	79	0xD2	210	R/W	0
ALD2		Level 3	Alarm2 mode selection (refer to ALD1)	22	0	0x50	80	0xD3	211	R/W	11
ALT2		Level 3	FLIK (00.00) : Flicker COTI (99.59) : Continued ON 00.01~99.58 : delay time	5999	0	0x51	81	0xD4	212	R/W	5999
HYA2		Level 3	Hysteresis setting for alarm2	1000	0	0x52	82	0xD5	213	R/W	0
SEA2		Level 3	Alarm2 special function setting	4369	0	0x53	83	0xD6	214	R/W	0
ALD3		Level 3	Alarm1 mode selection (refer to ALD1)	22	0	0x54	84	0xD7	215	R/W	11
ALT3		Level 3	FLIK (00.00) : Flicker COTI (99.59) : Continued ON 00.01~99.58 : delay time	5999	0	0x55	85	0xD8	216	R/W	5999
HYA3		Level 3	Hysteresis setting for alarm3	1000	0	0x56	86	0xD9	217	R/W	0

7. Communication Data List

Parameter	Display	Level	Description	Range		Address				R/W	Initial
				Max	Min	LOOP1		LOOP2			
						Hex	Dec	Hex	Dec		
SEA3	5000	Level 3	Alarm1 special function setting	4369	0	0x57	87	0xDA	218	R/W	0
MOCL	0000	Level 3	Main output zero calibration only for linear signal	9999	0	0x58	88	0xDB	219	R/W	0
MOCH	0000	Level 3	Main output span calibration only for linear signal	9999	0	0x59	89	0xDC	220	R/W	3600
SOCL	5000	Level 3	sub output zero calibration only for linear signal	9999	0	0x5A	90	0xDD	221	R/W	0
SOCH	5000	Level 3	sub output zero calibration only for linear signal	9999	0	0x5B	91	0xDE	222	R/W	3600
MV.SF	0000	Level 3	Analog input special function selection 0 : NONE (special function OFF) 1 : SQUA (analog input square) 2 : ROOT (analog input square root) 3 : REVE (analog input reverse) 4 : SQ.RE (analog input square reverse) 5 : RO.RE (analog input square root reverse)	5	0	0x5C	92	0xDF	223	R/W	0
RC.TI	0000	Level 3	Input digital filter Unit : second	99.99	0.01	0x5D	93	0xE0	224	R/W	0.10
UNIT	0000	Level 3	Unit 0 : °C 1 : °F 2 : U (Linear signal)	2	0	0x5E	94	0xE1	225	R/W	---
OUTM	0000	Level 3	Control action selection 0 : HEAT reverse action 1 : COOL direct action	1	0	0x5F	95	0xE2	226	R/W	0
SV.OS	5000	Level 3	SV bias	1000	-1000	0x60	96	0xE3	227	R/W	0
PV.OS	0000	Level 3	PV bias(for zero) $PV = PV \times (PV.OH / 5000) + PV.OS$	1000	-1000	0x61	97	0xE4	228	R/W	0
PV.OH	0000	Level 3	PV bias(for span) $PV = PV \times (PV.OH / 5000) + PV.OS$	9999	0	0x62	98	0xE5	229	R/W	5000
MLNB	0000	Level 3	Manual linear segment number	10	0	0x63	99	0xE6	230	R/W	0
COMP	0000	Level 3	Manual linear compare value	USPL	LSPL	0x64	100	0xE7	231	R/W	0
OFFS	0000	Level 3	Manual linear offset value	1500	-1500	0x65	101	0xE8	232	R/W	0
SV.TY	0000	Level 4	SV source selection LOOP1 0 : FIX (local SV) 1 : RATE (uart + rate SV) 2 : ANAG (remote 4~20mA SV) 3 : ANRA (remote 4~20mA + rate SV) 4 : RAMP (ramp SV) 5 : PROG (program SV) LOOP2 0 : FIX (local SV) 1 : RATE (uart + rate SV) 2 : ANAG (remote 4~20mA SV) 3 : ANRA (remote 4~20mA + rate SV) 4 : RAMP (ramp SV)	5	0	0x66	102	0xE9	233	R/W	0

Parameter	Display	Level	Description	Range		Address				R/W	Initial
				Max	Min	LOOP1		LOOP2			
						Hex	Dec	Hex	Dec		
OU.TY		Level 4	Hardware drive selection LOOP1 0 : SING (single output) 1 : DOUB (dual output) 2 : 1SCR (single phase control) 3 : HLST (high low signal selection) 4 : FBMV (valve control with feedback) 5 : NFMV (valve control without feedback) LOOP2 0 : SING (single output) 1 : DOUB (dual output) 2 : 1SCR (single phase control) 3 : HLST (high low signal selection) 4 : NFMV (valve control without feedback)	5	0	0x67	103	0xEA	234	R/W	0
RCGN		Level 4	Process RC constant.Gain	10.0	0.1	0x68	104	0xEB	235	R/W	1.0
FKSL		Level 4	FUN key function mode selection 0 : OFF (disable FUN key) 1 : R_S (switch RUN/STOP) 2 : A_M (switch auto/manual) 3 : AT (ON/OFF auto-tuning) 4 : LOOP (switch LOOP1/2)	1	0	0x69	105	0xEC	236	R/W	0
R_ER		Level 4	Ramp error 0 : OFF 1 : ON	1	0	0x6A	106	0xED	237	R/W	1
TP_K		Level 4	To target proportional band const.	100.0	1.0	0x6B	107	0xEE	238	R/W	35.0
SOCL		Level 3	sub output zero calibration only for linear signal	9999	0	0x5A	90	0xDD	221	R/W	0
TMSL		Level 4	24 hour timer , mode selection 0 : OFF (24 hour timer function disable) 1 : SWSV (switch SV) 2 : R_S (switch RUN/STOP) 3 : R_SO (switch to run)	100	1	0x6C	108	0xEF	239	R/W	1
MVRT		Level 4	Motor valve operating time	150	5	0x6D	109	0xF0	240	R/W	45
HYSM		Level 4	Motor valve hysteresis adjust	10.0	1.0	0x6E	110	0xF1	241	R/W	1.5
RH.TC		Level 4	Dehumidification temperature If PV less than RH.TC manipulated value = RH.PO	100.0	0.0	0x6F	111	0xF2	242	R/W	35.0
RH.PO		Level 4	Dehumidification manipulated value 0 : OFF disable dehumidification function Other values : 0.1~100.0 manipulated value	100.0	0.0	0x70	112	0xF3	243	R/W	0.0
RH.TM		Level 4	dehumidification time (time format : minute.second) 00.00~99.58 :execute dehumidification time	5999	0	0x71	113	0xF4	244	R/W	300
PR.SV		Level 4	reserve	USPL	LSPL	0x72	114	0xF5	245	R/W	100.0
AT.SV		Level 4	reserve	USPL	LSPL	0x73	115	0xF6	246	R/W	200.0
SET1		Level 4	Parameter group hide/display	4369	0	0x74	116	0xF7	247	R/W	---
SET2		Level 4	Parameter group hide/display	4369	0	0x75	117	0xF8	248	R/W	---
SET3		Level 4	Parameter group hide/display	4369	0	0x76	118	0xF9	249	R/W	---
SET4		Level 4	Parameter group hide/display	4369	0	0x77	119	0xFA	250	R/W	---
SET5		Level 4	Parameter group hide/display	4369	0	0x78	120	0xFB	251	R/W	---
SET6		Level 4	Parameter group hide/display	4369	0	0x79	121	0xFC	252	R/W	---
SET7		Level 4	Parameter group hide/display	4369	0	0x7A	122	0xFD	253	R/W	---

7. Communication Data List

Parameter	Display	Level	Description	Range		Address				R/W	Initial
				Max	Min	LOOP1		LOOP2			
						Hex	Dec	Hex	Dec		
SET8	5000	Level 4	Parameter group hide/display	4369	0	0x7B	123	0xFE	254	R/W	---
SET9	5000	Level 4	Parameter group hide/display	4369	0	0x7C	124	0xFF	255	R/W	---
SETA	5000	Level 4	Parameter group hide/display	4369	0	0x7D	125	0x100	256	R/W	---
SETB	5000	Level 4	Parameter group hide/display	4369	0	0x7E	126	0x101	257	R/W	---
SETC	5000	Level 4	Parameter group hide/display	4369	0	0x7F	127	0x102	258	R/W	---
SETD	5000	Level 4	Parameter group hide/display	4369	0	0x80	128	0x103	259	R/W	---
SETE	5000	Level 4	Parameter group hide/display	4369	0	0x81	129	0x104	260	R/W	---
SETF	5000	Level 4	Parameter group hide/display	4369	0	0x82	130	0x105	261	R/W	---
HZ	0000	Level 5	Power frequency 0 : 50HZ 1 : 60HZ	1	0	0x106	262	0x106	262	R/W	1
PRTO	0000	Level 5	Protocol selection 0 : TAIE 1 : MRTU	1	0	0x107	263	0x107	263	R/W	1
FOMA	0000	Level 5	Data format 0 : O_81 (parity bit=odd, stop bit=1) 1 : O_82 (parity bit=odd, stop bit=2) 2 : E_81 (parity bit=even, stop bit=1) 3 : E_82 (parity bit=even, stop bit=2) 4 : N_81 (parity bit=none, stop bit=1) 5 : N_82 (parity bit=none, stop bit=2)	5	0	0x108	264	0x108	264	R/W	0
IDNO	0000	Level 5	Controller address	255	0	0x109	265	0x109	265	R/W	1
BAUD	0000	Level 5	Baud rate 0 : 24(2400) 1 : 48(4800) 2 : 96(9600) 3 : 192(19200) 4 : 384(38400) 5 : 576(57600) 6 : 1152(115200) bps	6	0	0x10A	266	0x10A	266	R/W	4
RPDT	0000	Level 5	Response delay time(ms) When controller receive master command will delay this setting value then response master	250	0	0x10B	267	0x10B	267	R/W	0
AOEN	0000	Level 5	Retransmission function enable 0 : OFF (Disable) 1 : ON (Enable)	1	0	0x10C	268	0x10C	268	R/W	0
AOSL	0000	Level 5	Retransmission output signal source selection 0 : SV1 (Loop1 SV) 1 : PV1 (Loop1 PV) 2 : MV1 (Loop1 main out manipulated value) 3 : SV1R (Loop1 SV reverse) 4 : PV1R (Loop1 PV reverse) 5 : MV1R (Loop1 main out manipulated reverse value) 6 : SV2 (Loop2 SV) 7 : PV2 (Loop2 PV) 8 : MV2 (Loop2 main out manipulated value) 9 : SV2R (Loop2 SV reverse) 10 : PV2R (Loop2 PV reverse) 11 : MV2R (Loop2 main out manipulated reverse value)	12	0	0x10D	269	0x10D	269	R/W	0

Parameter	Display	Level	Description	Range		Address				R/W	Initial
				Max	Min	LOOP1		LOOP2			
						Hex	Dec	Hex	Dec		
AO.LO		Level 5	Retransmission output scale high	USPL	LSPL	0x10E	270	0x10E	270	R/W	LSPL
AO.HI		Level 5	Retransmission output scale low	USPL	LSPL	0x10F	271	0x10F	271	R/W	USPL
AOCL		Level 5	For retransmission zero calibration	9999	0	0x110	272	0x110	272	R/W	0
AOCH		Level 5	For retransmission span calibration	9999	0	0x111	273	0x111	273	R/W	3600
CTRT		Level 5	CT(current transformer)ratio setting value	1	0	0x112	274	0x112	274	R/W	0
D1SL		Level 5	LOOP1 digital input function selection 0 : OFF (disable digital input function) 1 : SWSV (switch 4 sets of SV) 2 : R_S (switch RUN/STOP) 3 : A_M (switch Auto/Manual) 4 : AT (ON/OFF auto-tuning) 5 : RESV (ON/OFF remote SV) 6 : AOEN (ON/OFF retransmission) 7 : TIM (ON/OFF timer) 8 : CNT(counter) 9 : PROG (run/reset program)	99	0	0x113	275	0x113	275	R/W	0
D2SL		Level 5	LOOP2 digital input function selection 0 : OFF (disable digital input function) 1 : SWSV (switch 4 sets of SV) 2 : R_S (switch RUN/STOP) 3 : A_M (switch Auto/Manual) 4 : AT (ON/OFF auto-tuning) 5 : RESV (ON/OFF remote SV) 6 : AOEN (ON/OFF retransmission) 7 : TIM (ON/OFF timer) 8 : CNT(counter) 9 : PROG (run/reset program)	99	0	0x114	276	0x114	276	R/W	0
REMO		Level 5	Remote control program execute OFF : program execute by key ON : program execute by digital input or communication	1	0	0x115	277	0x115	277	R/W	0
CJSL		Level 5	Cold junction compensation mode selection 0 : AUTO (auto cold junction compensation) 1 : MAN (manual cold junction compensation)	1	0	0x116	278	0x116	278	R/W	0
CJMN		Level 5	manual cold junction compensation temperature setting	500	-100	0x117	279	0x117	279	R/W	25
CJTC		Level 5	cold junction temperature display	---	---	0x118	280	0x118	280	R/W	---
W_MD		Level 5	EEPROM protection 0 : OFF communication write command only write to CPU RAM 1 : ON communication write command write to CPU RAM and EEPROM	1	0	0x119	281	0x119	281	R	1
RMAP		Level 5	Registered mapping 0 : OFF (disable registered mapping) 1 : FY (mapping to FY series memory address) 2 : FE (mapping to FE series memory address)	10	0	0x11A	282	0x11A	282	R/W	0

7. Communication Data List

Parameter	Display	Level	Description	Range		Address				R/W	Initial
				Max	Min	LOOP1		LOOP2			
						Hex	Dec	Hex	Dec		
OPSL		Level 5	Loop hardware distribution 0 : LOP1 loop1 main out drive out1 hardware , sub out drive out2 hardware (use for dual output) 1 : LOP2 loop2 main out drive out1 hardware , sub out drive out2 hardware (use for dual output) 2 : LP12 loop1 main out drive out1 hardware , loop2 main out drive out2 hardware (use for single output)	2	0	0x11B	283	0x11B	283	R/W	2
POTM		Level 5	Power-on delay time setting value	5999	0	0x11C	284	0x11C	284	R/W	0
PTMD		Level 5	Program time format 0 : SEC (minute.second) 1 : MIN (hour.minute) 2 : 50MS (50ms)	2	0	0x11D	285	0x11D	285	R/W	0
PVST		Level 5	Program execute start address 0 : OFF (execute from zero) 1 : FULT (execute from current PV , fully time) 2 : CUTT (execute from current PV , cut time)	2	0	0x11E	286	0x11E	286	R/W	2
REPT		Level 5	Program execute repeat 0 : OFF (disable repeat function) 1 : ON (Program execute repeat)	1	0	0x11F	287	0x11F	287	R/W	0
POWF		Level 5	Program execute power fail protection 0 : OFF (disable power fail protection) 1 : ON (enable power fail protection)	1	0	0x120	288	0x120	288	R/W	0
D01		Level 5	general register 1	32767	-32768	0x121	289	0x121	289	R/W	0
D02		Level 5	general register 2	32767	-32768	0x122	290	0x122	290	R/W	0
D03		Level 5	general register 3	32767	-32768	0x123	291	0x123	291	R/W	0
D04		Level 5	general register 4	32767	-32768	0x124	292	0x124	292	R/W	0
D05		Level 5	general register 5	32767	-32768	0x125	293	0x125	293	R/W	0
D06		Level 5	general register 6	32767	-32768	0x126	294	0x126	294	R/W	0
D07		Level 5	general register 7	32767	-32768	0x127	295	0x127	295	R/W	0
D08		Level 5	general register 8	32767	-32768	0x128	296	0x128	296	R/W	0
D09		Level 5	general register 9	32767	-32768	0x129	297	0x129	297	R/W	0
D10		Level 5	general register 10	32767	-32768	0x12A	298	0x12A	298	R/W	0
D11		Level 5	general register 11	32767	-32768	0x12B	299	0x12B	299	R/W	0
D12		Level 5	general register 12	32767	-32768	0x12C	300	0x12C	300	R/W	0
D13		Level 5	general register 13	32767	-32768	0x12D	301	0x12D	301	R/W	0
D14		Level 5	general register 14	32767	-32768	0x12E	302	0x12E	302	R/W	0
D15		Level 5	general register 15	32767	-32768	0x12F	303	0x12F	303	R/W	0
D16		Level 5	general register 16	32767	-32768	0x130	304	0x130	304	R/W	0
D17		Level 5	general register 17	32767	-32768	0x131	305	0x131	305	R/W	0

7. Communication Data List

Parameter	Display	Level	Description	Range		Address				R/W	Initial
				Max	Min	LOOP1		LOOP2			
						Hex	Dec	Hex	Dec		
D18		Level 5	general register 18	32767	-32768	0x132	306	0x132	306	R/W	0
D19		Level 5	general register 19	32767	-32768	0x133	307	0x133	307	R/W	0
D20		Level 5	general register 20	32767	-32768	0x134	308	0x134	308	R/W	0
MPW	---	---	Verification code	9999	0	0x3FE	1022	0x3FE	1022	R/W	0
MSG1	---	---	LOOP1 error message indicator bit 2 ⁰ = INER 2 ¹ = UUUU 2 ² = NNNN 2 ³ = AUTF 2 ⁴ = r 2 ⁵ = r 2 ⁶ = r 2 ⁷ = r 2 ⁸ = CJER 2 ⁹ = CJOR 2 ¹⁰ = CJNR 2 ¹¹ = ADCF 2 ¹² = RAMF 2 ¹³ = r 2 ¹⁴ = r 2 ¹⁵ = r ※ r:reserve	32767	-32768	0x407	1031	0x407	1031	R	---
LAP1	---	---	LOOP1 led message indicator bit 2 ⁰ = OUT1 2 ¹ = OUT2 2 ² = AT 2 ³ = AL1 2 ⁴ = AL2 2 ⁵ = AL3 2 ⁶ = COM 2 ⁷ = MAN 2 ⁸ = r 2 ⁹ = r 2 ¹⁰ = r 2 ¹¹ = r 2 ¹² = r 2 ¹³ = r 2 ¹⁴ = r 2 ¹⁵ = r ※ r:reserve	32767	-32768	0x408	1032	0x408	1032	R	---
PKE1	---	---	LOOP1 program remote control 2 ⁰ = r 2 ¹ = r 2 ² = r 2 ³ = r 2 ⁴ = r 2 ⁵ = r 2 ⁶ = r 2 ⁷ = r 2 ⁸ = 256 (RUN) 2 ⁹ = 512 (HALT) 2 ¹⁰ = 1024 (JUMP) 2 ¹¹ = 2048 (RESET) 2 ¹² = r 2 ¹³ = r 2 ¹⁴ = r 2 ¹⁵ = r ※ r:reserve	32767	-32767	0x409	1033	0x409	1033	R/W	---

7. Communication Data List

Parameter	Display	Level	Description	Range		Address				R/W	Initial
				Max	Min	LOOP1		LOOP2			
						Hex	Dec	Hex	Dec		
MSG2	---	---	LOOP2 error message indicator bit 2 ⁰ = INER 2 ¹ = UUUU 2 ² = NNNN 2 ³ = AUTF 2 ⁴ = r 2 ⁵ = r 2 ⁶ = r 2 ⁷ = r 2 ⁸ = CJER 2 ⁹ = CJOR 2 ¹⁰ = CJNR 2 ¹¹ = ADCF 2 ¹² = RAMF 2 ¹³ = r 2 ¹⁴ = r 2 ¹⁵ = r ※ r : reserve	32767	-32767	0x40A	1034	0x40A	1034	R	---
LAP2	---	---	LOOP2 led message indicator bit 2 ⁰ = OUT1 2 ¹ = OUT2 2 ² = AT 2 ³ = AL1 2 ⁴ = AL2 2 ⁵ = AL3 2 ⁶ = COM 2 ⁷ = MAN 2 ⁸ = r 2 ⁹ = r 2 ¹⁰ = r 2 ¹¹ = r 2 ¹² = r 2 ¹³ = r 2 ¹⁴ = r 2 ¹⁵ = r ※ r : reserve	32767	-32767	0x40B	1035	0x40C	1035	R	---
PKE2	---	---	LOOP2 program remote control 2 ⁰ = r 2 ¹ = r 2 ² = r 2 ³ = r 2 ⁴ = r 2 ⁵ = r 2 ⁶ = r 2 ⁷ = r 2 ⁸ = 256 (RUN) 2 ⁹ = 512 (HALT) 2 ¹⁰ = 1024 (JUMP) 2 ¹¹ = 2048 (RESET) 2 ¹² = r 2 ¹³ = r 2 ¹⁴ = r 2 ¹⁵ = r ※ r : reserve	32767	-32767	0x40C	1036	0x40C	1036	R/W	---
FEDI	---	---	Firmware edition	32767	-32767	0x40E	1038	0x40E	1038	R	---
1P10	---	---	LOOP1_PV x 10	32767	-32767	0x40F	1039	0x40F	1039	R	---
2P10	---	---	LOOP2_PV x 10	32767	-32767	0x410	1040	0x410	1040	R	---
1MMV	---	---	LOOP1 main out manipulated value	1000	0	0x411	1041	0x411	1041	R	---
1SMV	---	---	LOOP1 sub out manipulated value	1000	0	0x412	1042	0x412	1042	R	---
2MMV	---	---	LOOP2 main out manipulated value	1000	0	0x413	1043	0x413	1043	R	---
2SMV	---	---	LOOP2 sub out manipulated value	1000	0	0x414	1044	0x414	1044	R	---

7.2 Program Parameters Address

Pattern	Segment	Parameter	Address	
			Hex	Dec
PTN =1	SEG =1	L1SV	0x0183	387
		L2SV	0x0184	388
		TIMR	0x0185	389
		DO	0x0186	390
	SEG =2	L1SV	0x0187	391
		L2SV	0x0188	392
		TIMR	0x0189	393
		DO	0x018A	394
	SEG =3	L1SV	0x018B	395
		L2SV	0x018C	396
		TIMR	0x018D	397
		DO	0x018E	398
	SEG =4	L1SV	0x018F	399
		L2SV	0x0190	400
		TIMR	0x0191	401
		DO	0x0192	402
	SEG =5	L1SV	0x0193	403
		L2SV	0x0194	404
		TIMR	0x0195	405
		DO	0x0196	406
	SEG =6	L1SV	0x0197	407
		L2SV	0x0198	408
		TIMR	0x0199	409
		DO	0x019A	410
	SEG =7	L1SV	0x019B	411
		L2SV	0x019C	412
		TIMR	0x019D	413
		DO	0x019E	414
	SEG =8	L1SV	0x019F	415
		L2SV	0x01A0	416
		TIMR	0x01A1	417
		DO	0x01A2	418
	SEG =9	L1SV	0x01A3	419
		L2SV	0x01A4	420
		TIMR	0x01A5	421
		DO	0x01A6	422
	SEG =10	L1SV	0x01A7	423
		L2SV	0x01A8	424
		TIMR	0x01A9	425
		DO	0x01AA	426

Pattern	Segment	Parameter	Address	
			Hex	Dec
PTN =2	SEG =1	L1SV	0x01AB	427
		L2SV	0x01AC	428
		TIMR	0x01AD	429
		DO	0x01AE	430
	SEG =2	L1SV	0x01AF	431
		L2SV	0x01B0	432
		TIMR	0x01B1	433
		DO	0x01B2	434
	SEG =3	L1SV	0x01B3	435
		L2SV	0x01B4	436
		TIMR	0x01B5	437
		DO	0x01B6	438
	SEG =4	L1SV	0x01B7	439
		L2SV	0x01B8	440
		TIMR	0x01B9	441
		DO	0x01BA	442
	SEG =5	L1SV	0x01BB	443
		L2SV	0x01BC	444
		TIMR	0x01BD	445
		DO	0x01BE	446
	SEG =6	L1SV	0x01BF	447
		L2SV	0x01C0	448
		TIMR	0x01C1	449
		DO	0x01C2	450
	SEG =7	L1SV	0x01C3	451
		L2SV	0x01C4	452
		TIMR	0x01C5	453
		DO	0x01C6	454
	SEG =8	L1SV	0x01C7	455
		L2SV	0x01C8	456
		TIMR	0x01C9	457
		DO	0x01CA	458
	SEG =9	L1SV	0x01CB	459
		L2SV	0x01CC	460
		TIMR	0x01CD	461
		DO	0x01CE	462
	SEG =10	L1SV	0x01CF	463
		L2SV	0x01D0	464
		TIMR	0x01D1	465
		DO	0x01D2	466

7. Communication Data List

Pattern	Segment	Parameter	Address	
			Hex	Dec
PTN =3	SEG =1	L1SV	0x01D3	467
		L2SV	0x01D4	468
		TIMR	0x01D5	469
		DO	0x01D6	470
	SEG =2	L1SV	0x01D7	471
		L2SV	0x01D8	472
		TIMR	0x01D9	473
		DO	0x01DA	474
	SEG =3	L1SV	0x01DB	475
		L2SV	0x01DC	476
		TIMR	0x01DD	477
		DO	0x01DE	478
	SEG =4	L1SV	0x01DF	479
		L2SV	0x01E0	480
		TIMR	0x01E1	481
		DO	0x01E2	482
	SEG =5	L1SV	0x01E3	483
		L2SV	0x01E4	484
		TIMR	0x01E5	485
		DO	0x01E6	486
	SEG =6	L1SV	0x01E7	487
		L2SV	0x01E8	488
		TIMR	0x01E9	489
		DO	0x01EA	490
	SEG =7	L1SV	0x01EB	491
		L2SV	0x01EC	492
		TIMR	0x01ED	493
		DO	0x01EE	494
	SEG =8	L1SV	0x01EF	495
		L2SV	0x01F0	496
		TIMR	0x01F1	497
		DO	0x01F2	498
	SEG =9	L1SV	0x01F3	499
		L2SV	0x01F4	500
		TIMR	0x01F5	501
		DO	0x01F6	502
	SEG =10	L1SV	0x01F7	503
		L2SV	0x01F8	504
		TIMR	0x01F9	505
		DO	0x01FA	506

Pattern	Segment	Parameter	Address	
			Hex	Dec
PTN =4	SEG =1	L1SV	0x01FB	507
		L2SV	0x01FC	508
		TIMR	0x01FD	509
		DO	0x01FE	510
	SEG =2	L1SV	0x01FF	511
		L2SV	0x0200	512
		TIMR	0x0201	513
		DO	0x0202	514
	SEG =3	L1SV	0x0203	515
		L2SV	0x0204	516
		TIMR	0x0205	517
		DO	0x0206	518
	SEG =4	L1SV	0x0207	519
		L2SV	0x0208	520
		TIMR	0x0209	521
		DO	0x020A	522
	SEG =5	L1SV	0x020B	523
		L2SV	0x020C	524
		TIMR	0x020D	525
		DO	0x020E	526
	SEG =6	L1SV	0x020F	527
		L2SV	0x0210	528
		TIMR	0x0211	529
		DO	0x0212	530
	SEG =7	L1SV	0x0213	531
		L2SV	0x0214	532
		TIMR	0x0215	533
		DO	0x0216	534
	SEG =8	L1SV	0x0217	535
		L2SV	0x0218	536
		TIMR	0x0219	537
		DO	0x021A	538
	SEG =9	L1SV	0x021B	539
		L2SV	0x021C	540
		TIMR	0x021D	541
		DO	0x021E	542
	SEG =10	L1SV	0x021F	543
		L2SV	0x0220	544
		TIMR	0x0221	545
		DO	0x0222	546

Pattern	Segment	Parameter	Address	
			Hex	Dec
PTN =5	SEG =1	L1SV	0x0223	547
		L2SV	0x0224	548
		TIMR	0x0225	549
		DO	0x0226	550
	SEG =2	L1SV	0x0227	551
		L2SV	0x0228	552
		TIMR	0x0229	553
		DO	0x022A	554
	SEG =3	L1SV	0x022B	555
		L2SV	0x022C	556
		TIMR	0x022D	557
		DO	0x022E	558
	SEG =4	L1SV	0x022F	559
		L2SV	0x0230	560
		TIMR	0x0231	561
		DO	0x0232	562
	SEG =5	L1SV	0x0233	563
		L2SV	0x0234	564
		TIMR	0x0235	565
		DO	0x0236	566
	SEG =6	L1SV	0x0237	567
		L2SV	0x0238	568
		TIMR	0x0239	569
		DO	0x023A	570
	SEG =7	L1SV	0x023B	571
		L2SV	0x023C	572
		TIMR	0x023D	573
		DO	0x023E	574
	SEG =8	L1SV	0x023F	575
		L2SV	0x0240	576
		TIMR	0x0241	577
		DO	0x0242	578
	SEG =9	L1SV	0x0243	579
		L2SV	0x0244	580
		TIMR	0x0245	581
		DO	0x0246	582
	SEG =10	L1SV	0x0247	583
		L2SV	0x0248	584
		TIMR	0x0249	585
		DO	0x024A	586

Pattern	Segment	Parameter	Address	
			Hex	Dec
PTN =6	SEG =1	L1SV	0x024B	587
		L2SV	0x024C	588
		TIMR	0x024D	589
		DO	0x024E	590
	SEG =2	L1SV	0x024F	591
		L2SV	0x0250	592
		TIMR	0x0251	593
		DO	0x0252	594
	SEG =3	L1SV	0x0253	595
		L2SV	0x0254	596
		TIMR	0x0255	597
		DO	0x0256	598
	SEG =4	L1SV	0x0257	599
		L2SV	0x0258	600
		TIMR	0x0259	601
		DO	0x025A	602
	SEG =5	L1SV	0x025B	603
		L2SV	0x025C	604
		TIMR	0x025D	605
		DO	0x025E	606
	SEG =6	L1SV	0x025F	607
		L2SV	0x0260	608
		TIMR	0x0261	609
		DO	0x0262	610
	SEG =7	L1SV	0x0263	611
		L2SV	0x0264	612
		TIMR	0x0265	613
		DO	0x0266	614
	SEG =8	L1SV	0x0267	615
		L2SV	0x0268	616
		TIMR	0x0269	617
		DO	0x026A	618
	SEG =9	L1SV	0x026B	619
		L2SV	0x026C	620
		TIMR	0x026D	621
		DO	0x026E	622
	SEG =10	L1SV	0x026F	623
		L2SV	0x0270	624
		TIMR	0x0271	625
		DO	0x0272	626

7. Communication Data List

Pattern	Segment	Parameter	Address	
			Hex	Dec
PTN =7	SEG =1	L1SV	0x0273	627
		L2SV	0x0274	628
		TIMR	0x0275	629
		DO	0x0276	630
	SEG =2	L1SV	0x0277	631
		L2SV	0x0278	632
		TIMR	0x0279	633
		DO	0x027A	634
	SEG =3	L1SV	0x027B	635
		L2SV	0x027C	636
		TIMR	0x027D	637
		DO	0x027E	638
	SEG =4	L1SV	0x027F	639
		L2SV	0x0280	640
		TIMR	0x0281	641
		DO	0x0282	642
	SEG =5	L1SV	0x0283	643
		L2SV	0x0284	644
		TIMR	0x0285	645
		DO	0x0286	646
	SEG =6	L1SV	0x0287	647
		L2SV	0x0288	648
		TIMR	0x0289	649
		DO	0x028A	650
	SEG =7	L1SV	0x028B	651
		L2SV	0x028C	652
		TIMR	0x028D	653
		DO	0x028E	654
	SEG =8	L1SV	0x028F	655
		L2SV	0x0290	656
		TIMR	0x0291	657
		DO	0x0292	658
	SEG =9	L1SV	0x0293	659
		L2SV	0x0294	660
		TIMR	0x0295	661
		DO	0x0296	662
	SEG =10	L1SV	0x0297	663
		L2SV	0x0298	664
		TIMR	0x0299	665
		DO	0x029A	666

Pattern	Segment	Parameter	Address	
			Hex	Dec
PTN =8	SEG =1	L1SV	0x029B	667
		L2SV	0x029C	668
		TIMR	0x029D	669
		DO	0x029E	670
	SEG =2	L1SV	0x029F	671
		L2SV	0x02A0	672
		TIMR	0x02A1	673
		DO	0x02A2	674
	SEG =3	L1SV	0x02A3	675
		L2SV	0x02A4	676
		TIMR	0x02A5	677
		DO	0x02A6	678
	SEG =4	L1SV	0x02A7	679
		L2SV	0x02A8	680
		TIMR	0x02A9	681
		DO	0x02AA	682
	SEG =5	L1SV	0x02AB	683
		L2SV	0x02AC	684
		TIMR	0x02AD	685
		DO	0x02AE	686
	SEG =6	L1SV	0x02AF	687
		L2SV	0x02B0	688
		TIMR	0x02B1	689
		DO	0x02B2	690
	SEG =7	L1SV	0x02B3	691
		L2SV	0x02B4	692
		TIMR	0x02B5	693
		DO	0x02B6	694
	SEG =8	L1SV	0x02B7	695
		L2SV	0x02B8	696
		TIMR	0x02B9	697
		DO	0x02BA	698
	SEG =9	L1SV	0x02BB	699
		L2SV	0x02BC	700
		TIMR	0x02BD	701
		DO	0x02BE	702
	SEG =10	L1SV	0x02BF	703
		L2SV	0x02C0	704
		TIMR	0x02C1	705
		DO	0x02C2	706

Pattern	Segment	Parameter	Address	
			Hex	Dec
PTN =9	SEG =1	L1SV	0x02C3	707
		L2SV	0x02C4	708
		TIMR	0x02C5	709
		DO	0x02C6	710
	SEG =2	L1SV	0x02C7	711
		L2SV	0x02C8	712
		TIMR	0x02C9	713
		DO	0x02CA	714
	SEG =3	L1SV	0x02CB	715
		L2SV	0x02CC	716
		TIMR	0x02CD	717
		DO	0x02CE	718
	SEG =4	L1SV	0x02CF	719
		L2SV	0x02D0	720
		TIMR	0x02D1	721
		DO	0x02D2	722
	SEG =5	L1SV	0x02D3	723
		L2SV	0x02D4	724
		TIMR	0x02D5	725
		DO	0x02D6	726
	SEG =6	L1SV	0x02D7	727
		L2SV	0x02D8	728
		TIMR	0x02D9	729
		DO	0x02DA	730
	SEG =7	L1SV	0x02DB	731
		L2SV	0x02DC	732
		TIMR	0x02DD	733
		DO	0x02DE	734
	SEG =8	L1SV	0x02DF	735
		L2SV	0x02E0	736
		TIMR	0x02E1	737
		DO	0x02E2	738
	SEG =9	L1SV	0x02E3	739
		L2SV	0x02E4	740
		TIMR	0x02E5	741
		DO	0x02E6	742
	SEG =10	L1SV	0x02E7	743
		L2SV	0x02E8	744
		TIMR	0x02E9	745
		DO	0x02EA	746

Pattern	Segment	Parameter	Address	
			Hex	Dec
PTN =10	SEG =1	L1SV	0x02EB	747
		L2SV	0x02EC	748
		TIMR	0x02ED	749
		DO	0x02EE	750
	SEG =2	L1SV	0x02EF	751
		L2SV	0x02F0	752
		TIMR	0x02F1	753
		DO	0x02F2	754
	SEG =3	L1SV	0x02F3	755
		L2SV	0x02F4	756
		TIMR	0x02F5	757
		DO	0x02F6	758
	SEG =4	L1SV	0x02F7	759
		L2SV	0x02F8	760
		TIMR	0x02F9	761
		DO	0x02FA	762
	SEG =5	L1SV	0x02FB	763
		L2SV	0x02FC	764
		TIMR	0x02FD	765
		DO	0x02FE	766
	SEG =6	L1SV	0x02FF	767
		L2SV	0x0300	768
		TIMR	0x0301	769
		DO	0x0302	770
	SEG =7	L1SV	0x0303	771
		L2SV	0x0304	772
		TIMR	0x0305	773
		DO	0x0306	774
	SEG =8	L1SV	0x0307	775
		L2SV	0x0308	776
		TIMR	0x0309	777
		DO	0x030A	778
	SEG =9	L1SV	0x030B	779
		L2SV	0x030C	780
		TIMR	0x030D	781
		DO	0x030E	782
	SEG =10	L1SV	0x030F	783
		L2SV	0x0310	784
		TIMR	0x0311	785
		DO	0x0312	786

7. Communication Data List

Pattern	Segment	Parameter	Address	
			Hex	Dec
PTN =11	SEG =1	L1SV	0x0313	787
		L2SV	0x0314	788
		TIMR	0x0315	789
		DO	0x0316	790
	SEG =2	L1SV	0x0317	791
		L2SV	0x0318	792
		TIMR	0x0319	793
		DO	0x031A	794
	SEG =3	L1SV	0x031B	795
		L2SV	0x031C	796
		TIMR	0x031D	797
		DO	0x031E	798
	SEG =4	L1SV	0x031F	799
		L2SV	0x0320	800
		TIMR	0x0321	801
		DO	0x0322	802
	SEG =5	L1SV	0x0323	803
		L2SV	0x0324	804
		TIMR	0x0325	805
		DO	0x0326	806
	SEG =6	L1SV	0x0327	807
		L2SV	0x0328	808
		TIMR	0x0329	809
		DO	0x032A	810
	SEG =7	L1SV	0x032B	811
		L2SV	0x032C	812
		TIMR	0x032D	813
		DO	0x032E	814
	SEG =8	L1SV	0x032F	815
		L2SV	0x0330	816
		TIMR	0x0331	817
		DO	0x0332	818
	SEG =9	L1SV	0x0333	819
		L2SV	0x0334	820
		TIMR	0x0335	821
		DO	0x0336	822
	SEG =10	L1SV	0x0337	823
		L2SV	0x0338	824
		TIMR	0x0339	825
		DO	0x033A	826

Pattern	Segment	Parameter	Address	
			Hex	Dec
PTN =12	SEG =1	L1SV	0x033B	827
		L2SV	0x033C	828
		TIMR	0x033D	829
		DO	0x033E	830
	SEG =2	L1SV	0x033F	831
		L2SV	0x0340	832
		TIMR	0x0341	833
		DO	0x0342	834
	SEG =3	L1SV	0x0343	835
		L2SV	0x0344	836
		TIMR	0x0345	837
		DO	0x0346	838
	SEG =4	L1SV	0x0347	839
		L2SV	0x0348	840
		TIMR	0x0349	841
		DO	0x034A	842
	SEG =5	L1SV	0x034B	843
		L2SV	0x034C	844
		TIMR	0x034D	845
		DO	0x034E	846
	SEG =6	L1SV	0x034F	847
		L2SV	0x0350	848
		TIMR	0x0351	849
		DO	0x0352	850
	SEG =7	L1SV	0x0353	851
		L2SV	0x0354	852
		TIMR	0x0355	853
		DO	0x0356	854
	SEG =8	L1SV	0x0357	855
		L2SV	0x0358	856
		TIMR	0x0359	857
		DO	0x035A	858
	SEG =9	L1SV	0x035B	859
		L2SV	0x035C	860
		TIMR	0x035D	861
		DO	0x035E	862
	SEG =10	L1SV	0x035F	863
		L2SV	0x0360	864
		TIMR	0x0361	865
		DO	0x0362	866

Pattern	Segment	Parameter	Address	
			Hex	Dec
PTN =13	SEG =1	L1SV	0x0363	867
		L2SV	0x0364	868
		TIMR	0x0365	869
		DO	0x0366	870
	SEG =2	L1SV	0x0367	871
		L2SV	0x0368	872
		TIMR	0x0369	873
		DO	0x036A	874
	SEG =3	L1SV	0x036B	875
		L2SV	0x036C	876
		TIMR	0x036D	877
		DO	0x036E	878
	SEG =4	L1SV	0x036F	879
		L2SV	0x0370	880
		TIMR	0x0371	881
		DO	0x0372	882
	SEG =5	L1SV	0x0373	883
		L2SV	0x0374	884
		TIMR	0x0375	885
		DO	0x0376	886
	SEG =6	L1SV	0x0377	887
		L2SV	0x0378	888
		TIMR	0x0379	889
		DO	0x037A	890
	SEG =7	L1SV	0x037B	891
		L2SV	0x037C	892
		TIMR	0x037D	893
		DO	0x037E	894
	SEG =8	L1SV	0x037F	895
		L2SV	0x0380	896
		TIMR	0x0381	897
		DO	0x0382	898
	SEG =9	L1SV	0x0383	899
		L2SV	0x0384	900
		TIMR	0x0385	901
		DO	0x0386	902
	SEG =10	L1SV	0x0387	903
		L2SV	0x0388	904
		TIMR	0x0389	905
		DO	0x038A	906

Pattern	Segment	Parameter	Address	
			Hex	Dec
PTN =14	SEG =1	L1SV	0x038B	907
		L2SV	0x038C	908
		TIMR	0x038D	909
		DO	0x038E	910
	SEG =2	L1SV	0x038F	911
		L2SV	0x0390	912
		TIMR	0x0391	913
		DO	0x0392	914
	SEG =3	L1SV	0x0393	915
		L2SV	0x0394	916
		TIMR	0x0395	917
		DO	0x0396	918
	SEG =4	L1SV	0x0397	919
		L2SV	0x0398	920
		TIMR	0x0399	921
		DO	0x039A	922
	SEG =5	L1SV	0x039B	923
		L2SV	0x039C	924
		TIMR	0x039D	925
		DO	0x039E	926
	SEG =6	L1SV	0x039F	927
		L2SV	0x03A0	928
		TIMR	0x03A1	929
		DO	0x03A2	930
	SEG =7	L1SV	0x03A3	931
		L2SV	0x03A4	932
		TIMR	0x03A5	933
		DO	0x03A6	934
	SEG =8	L1SV	0x03A7	935
		L2SV	0x03A8	936
		TIMR	0x03A9	937
		DO	0x03AA	938
	SEG =9	L1SV	0x03AB	939
		L2SV	0x03AC	940
		TIMR	0x03AD	941
		DO	0x03AE	942
	SEG =10	L1SV	0x03AF	943
		L2SV	0x03B0	944
		TIMR	0x03B1	945
		DO	0x03B2	946



台灣儀控股份有限公司
TAIWAN INSTRUMENT & CONTROL CO., LTD

Phone: +886-2-8226-1867
Fax: +886-2-8226-1834

E-mail: contact@fa-taie.com.tw
URL: <http://www.fa-taie.com.tw>



2018.04.27